

SERVICE MANUAL

R410A

Outdoor unit
[Model name]

PUHZ-SW40VHA

PUHZ-SW50VHA

[Service Ref.]

PUHZ-SW40VHA

PUHZ-SW50VHA

Note:

- This manual describes only service data of the outdoor units.

Salt proof model

PUHZ-SW40VHA-BS

PUHZ-SW50VHA-BS

PUHZ-SW40VHA-BS

PUHZ-SW50VHA-BS

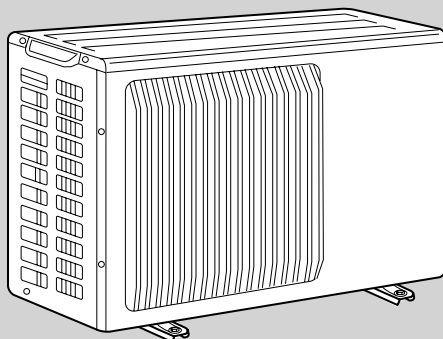

CONTENTS

1 REFERENCE MANUAL	2
2 SAFETY PRECAUTION	2
3 FEATURES	6
4 SPECIFICATIONS	6
5 DATA	8
6 OUTLINES AND DIMENSIONS	9
7 WIRING DIAGRAM	10
8 WIRING SPECIFICATIONS	11
9 REFRIGERANT SYSTEM DIAGRAM	12
10 TROUBLESHOOTING	14
11 DISASSEMBLY PROCEDURE	55

PARTS CATALOG (OCB525)

INDOOR UNIT SERVICE MANUAL

Model name	Service ref.	Service manual No.
EHST20C-VM6HB EHST20C-YM9HB EHST20C-VM6B EHST20C-YM9B EHST20C-VM6EB EHST20C-YM9EB EHST20C-VM6SB EHPT20X-VM2HB EHPT20X-VM6HB EHPT20X-YM9HB EHPT20X-VM6B EHPT20X-YM9B	EHST20C-VM6HB.UK EHST20C-YM9HB.UK EHST20C-VM6B.UK EHST20C-YM9B.UK EHST20C-VM6EB.UK EHST20C-YM9EB.UK EHST20C-VM6SB.UK EHPT20X-VM2HB.UK EHPT20X-VM6HB.UK EHPT20X-YM9HB.UK EHPT20X-VM6B.UK EHPT20X-YM9B.UK	OCH531
EHSC-VM6B EHSC-YM9B EHSC-VM6EB EHSC-YM9EB EHPX-VM2B EHPX-VM6B EHPX-YM9B ERSC-VM2B	EHSC-VM6B.UK EHSC-YM9B.UK EHSC-VM6EB.UK EHSC-YM9EB.UK EHPX-VM2B.UK EHPX-VM6B.UK EHPX-YM9B.UK ERSC-VM2B.UK	OCH532

2-1. ALWAYS OBSERVE FOR SAFETY

Before obtaining access to terminal, all supply circuits must be disconnected.

2-2. CAUTIONS RELATED TO NEW REFRIGERANT

Cautions for units utilizing refrigerant R410A

Preparation before the repair service.

- Prepare the proper tools.
- Prepare the proper protectors.
- Provide adequate ventilation.
- After stopping the operation of the air conditioner, turn off the power-supply breaker.
- Discharge the condenser before the work involving the electric parts.

Precautions during the repair service.

- Do not perform the work involving the electric parts with wet hands.
- Do not pour water into the electric parts.
- Do not touch the refrigerant.
- Do not touch the hot or cold areas in the refrigerating cycle.
- When the repair or the inspection of the circuit needs to be done without turning off the power, exercise great caution not to touch the live parts.

Use new refrigerant pipes.

- In case of using the existing pipes for R22, be careful with the followings.
- Be sure to clean the pipes and make sure that the insides of the pipes are clean.
 - Change flare nut to the one provided with this product. Use a newly flared pipe.
 - Avoid using thin pipes.

Make sure that the inside and outside of refrigerant piping is clean and it has no contaminants such as sulfur, oxides, dirt, shaving particles, etc, which are hazard to refrigerant cycle. In addition, use pipes with specified thickness.

Contamination inside refrigerant piping can cause deterioration of refrigerant oil etc.

Do not use refrigerant other than R410A.

If other refrigerant (R22 etc.) is used, chlorine in refrigerant can cause deterioration of refrigerant oil etc.

Use a vacuum pump with a reverse flow check valve.

Vacuum pump oil may flow back into refrigerant cycle and that can cause deterioration of refrigerant oil etc.

Store the piping indoors, and both ends of the piping sealed until just before brazing. (Leave elbow joints, etc. in their packaging.)

If dirt, dust or moisture enters into refrigerant cycle, that can cause deterioration of refrigerant oil or malfunction of compressor.

The refrigerant oil applied to flare and flange connections must be ester oil, ether oil or alkylbenzene oil in a small amount.

If large amount of mineral oil enters, that can cause deterioration of refrigerant oil etc.

Charge refrigerant from liquid phase of gas cylinder.

If the refrigerant is charged from gas phase, composition change may occur in refrigerant and the efficiency will be lowered.

Use the specified refrigerant only.

Never use any refrigerant other than that specified.
Doing so may cause a burst, an explosion, or fire when the unit is being used, serviced, or disposed of.
Correct refrigerant is specified in the manuals and on the spec labels provided with our products.
We will not be held responsible for mechanical failure, system malfunction, unit breakdown or accidents caused by failure to follow the instructions.

Use the following tools specifically designed for use with R410A refrigerant.

The following tools are necessary to use R410A refrigerant.

Tools for R410A	
Gauge manifold	Flare tool
Charge hose	Size adjustment gauge
Gas leak detector	Vacuum pump adaptor
Torque wrench	Electronic refrigerant charging scale

Handle tools with care.

If dirt, dust or moisture enters into refrigerant cycle, that can cause deterioration of refrigerant oil or malfunction of compressor.

Do not use a charging cylinder.

If a charging cylinder is used, the composition of refrigerant will change and the efficiency will be lowered.

Ventilate the room if refrigerant leaks during operation. If refrigerant comes into contact with a flame, poisonous gases will be released.

[1] Cautions for service

- (1) Perform service after recovering the refrigerant left in unit completely.
- (2) Do not release refrigerant in the air.
- (3) After completing service, charge the cycle with specified amount of refrigerant.
- (4) When performing service, install a filter drier simultaneously.
Be sure to use a filter drier for new refrigerant.

[2] Additional refrigerant charge

When charging directly from cylinder

- Check that cylinder for R410A on the market is syphon type.
- Charging should be performed with the cylinder of syphon stood vertically. (Refrigerant is charged from liquid phase.)

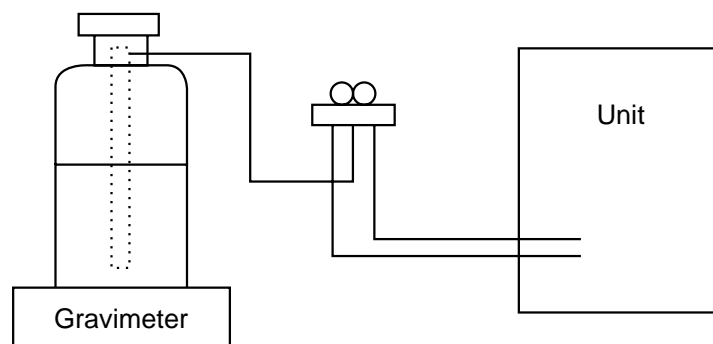

[3] Service tools

Use the below service tools as exclusive tools for R410A refrigerant.

No.	Tool name	Specifications
①	Gauge manifold	<ul style="list-style-type: none"> · Only for R410A · Use the existing fitting specifications. (UNF1/2) · Use high-tension side pressure of 5.3MPa-G or over.
②	Charge hose	<ul style="list-style-type: none"> · Only for R410A · Use pressure performance of 5.09MPa-G or over.
③	Electronic scale	—
④	Gas leak detector	· Use the detector for R134a, R407C or R410A.
⑤	Adaptor for reverse flow check	· Attach on vacuum pump.
⑥	Refrigerant charge base	—
⑦	Refrigerant cylinder	<ul style="list-style-type: none"> · Only for R410A · Top of cylinder (Pink) · Cylinder with syphon
⑧	Refrigerant recovery equipment	—

2-3. PRECAUTIONS WHEN REUSING EXISTING R22 REFRIGERANT PIPES

(1) Flowchart

- Refer to the flowchart below to determine if the existing pipes can be used and if it is necessary to use a filter dryer.
- If the diameter of the existing pipes is different from the specified diameter, refer to technological data materials to confirm if the pipes can be used.

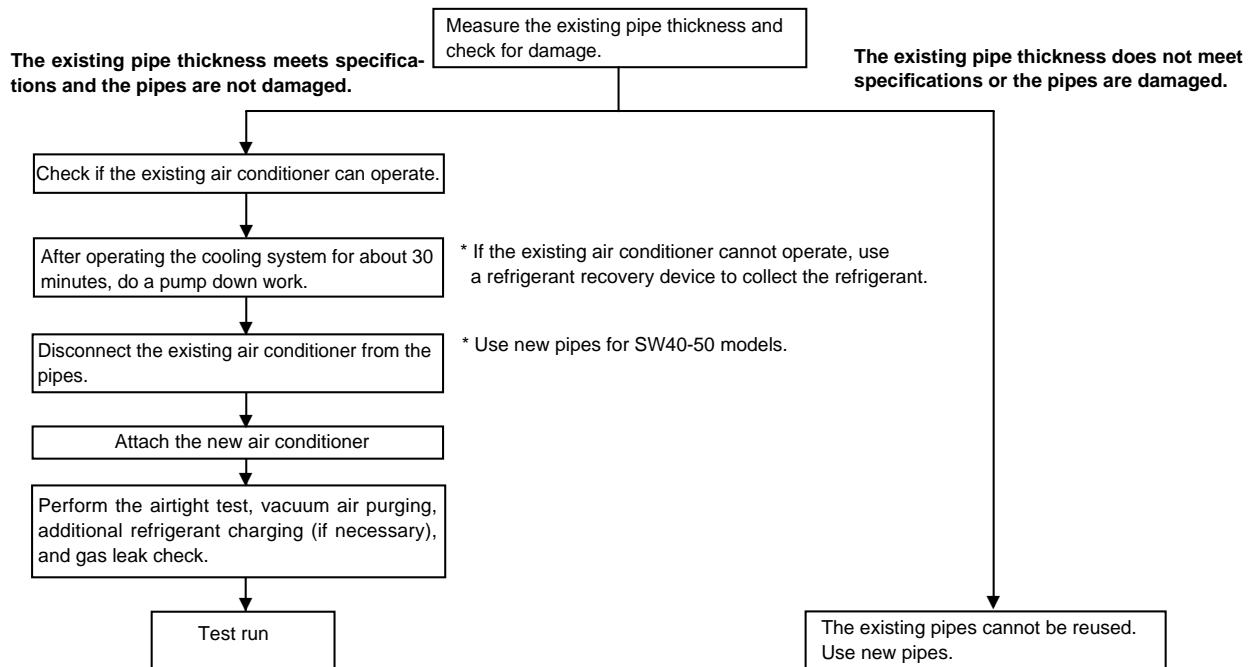

2-4. PRECAUTIONS FOR SALT PROOF TYPE "-BS" MODEL

Although "-BS" model has been designed to be resistant to salt damage, observe the following precautions to maintain the performance of the unit.

1. Avoid installing the unit in a location where it will be exposed directly to seawater or sea breeze.
2. If the cover panel may become covered with salt, be sure to install the unit in a location where the salt will be washed away by rainwater. (If a sunshade is installed, rainwater may not clean the panel.)
3. To ensure that water does not collect in the base of the outdoor unit, make sure that the base is level, not at angle. Water collecting in the base of the outdoor unit could cause rust.
4. If the unit is installed in a coastal area, clean the unit with water regularly to remove any salt build-up.
5. If the unit is damaged during installation or maintenance, be sure to repair it.
6. Be sure to check the condition of the unit regularly.
7. Be sure to install the unit in a location with good drainage.

(2) Cautions for refrigerant piping work

New refrigerant R410A is adopted for replacement inverter series. Although the refrigerant piping work for R410A is same as for R22, exclusive tools are necessary so as not to mix with different kind of refrigerant. Furthermore as the working pressure of R410A is 1.6 times higher than that of R22, their sizes of flared sections and flare nuts are different.

① Thickness of pipes

Because the working pressure of R410A is higher compared to R22, be sure to use refrigerant piping with thickness shown below. (Never use pipes of 0.7 mm or below.)

Diagram below: Piping diameter and thickness

Nominal dimensions(inch)	Outside diameter (mm)	Thickness (mm)	
		R410A	R22
1/4	6.35	0.8	0.8
3/8	9.52	0.8	0.8
1/2	12.70	0.8	0.8
5/8	15.88	1.0	1.0
3/4	19.05	—	1.0

② Dimensions of flare cutting and flare nut

The component molecules in HFC refrigerant are smaller compared to conventional refrigerants. In addition to that, R410A is a refrigerant, which has higher risk of leakage because its working pressure is higher than that of other refrigerants. Therefore, to enhance airtightness and intensity, flare cutting dimension of copper pipe for R410A has been specified separately from the dimensions for other refrigerants as shown below. The dimension B of flare nut for R410A also has partly been changed to increase intensity as shown below. Set copper pipe correctly referring to copper pipe flaring dimensions for R410A below. For 1/2 and 5/8 inch, the dimension B changes. Use torque wrench corresponding to each dimension.

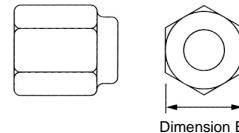
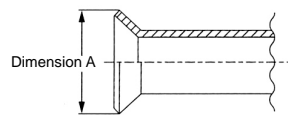

Flare cutting dimensions (mm)

Nominal dimensions(inch)	Outside diameter	Dimension A (mm)	
		R410A	R22
1/4	6.35	9.1	9.0
3/8	9.52	13.2	13.0
1/2	12.70	16.6	16.2
5/8	15.88	19.7	19.4
3/4	19.05	—	23.3

Flare nut dimensions (mm)

Nominal dimensions(inch)	Outside diameter	Dimension B (mm)	
		R410A	R22
1/4	6.35	17.0	17.0
3/8	9.52	22.0	22.0
1/2	12.70	26.0	24.0
5/8	15.88	29.0	27.0
3/4	19.05	—	36.0

③ Tools for R410A (The following table shows whether conventional tools can be used or not.)

Tools and materials	Use	R410A tools	Can R22 tools be used?	Can R407C tools be used?
Gauge manifold	Air purge, refrigerant charge and operation check	Tool exclusive for R410A	×	×
Charge hose		Tool exclusive for R410A	×	×
Gas leak detector	Gas leak check	Tool for HFC refrigerant	×	○
Refrigerant recovery equipment	Refrigerant recovery	Tool exclusive for R410A	×	×
Refrigerant cylinder	Refrigerant charge	Tool exclusive for R410A	×	×
Applied oil	Apply to flared section	Ester oil and alkylbenzene oil (minimum amount)	×	Ester oil: ○ Alkylbenzene oil: minimum amount
Safety charger	Prevent compressor malfunction when charging refrigerant by spraying liquid refrigerant	Tool exclusive for R410A	×	×
Charge valve	Prevent gas from blowing out when detaching charge hose	Tool exclusive for R410A	×	×
Vacuum pump	Vacuum drying and air purge	Tools for other refrigerants can be used if equipped with adapter for reverse flow check	△ (Usable if equipped with adapter for reverse flow)	△ (Usable if equipped with adapter for reverse flow)
Flare tool	Flaring work of piping	Tools for other refrigerants can be used by adjusting flaring dimension	△ (Usable by adjusting flaring dimension)	△ (Usable by adjusting flaring dimension)
Bender	Bend the pipes	Tools for other refrigerants can be used	○	○
Pipe cutter	Cut the pipes	Tools for other refrigerants can be used	○	○
Welder and nitrogen gas cylinder	Weld the pipes	Tools for other refrigerants can be used	○	○
Refrigerant charging scale	Refrigerant charge	Tools for other refrigerants can be used	○	○
Vacuum gauge or thermistor vacuum gauge and vacuum valve	Check the degree of vacuum. (Vacuum valve prevents back flow of oil and refrigerant to thermistor vacuum gauge)	Tools for other refrigerants can be used	○	○
Charging cylinder	Refrigerant charge	Tool exclusive for R410A	×	—

× : Prepare a new tool. (Use the new tool as the tool exclusive for R410A.)

△ : Tools for other refrigerants can be used under certain conditions.

○ : Tools for other refrigerants can be used.

3

FEATURES

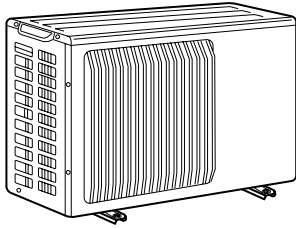

PUHZ-SW40VHA
PUHZ-SW40VHA-BS
PUHZ-SW50VHA
PUHZ-SW50VHA-BS

CHARGELESS SYSTEM

PRE-CHARGED REFRIGERANT IS SUPPLIED FOR PIPING LENGTH AT SHIPMENT

Max. 10m (PUHZ-SW40/SW50)

The refrigerant circuit with LEV (Linear Expansion Valve) and power receiver always control the optimal refrigerant level regardless of the length (10 m max. and 5 m min.) of piping. The additional refrigerant charging work during installation often causes problems. It is completely eliminated by chargeless system. This unique system improves the quality and reliability of the work done. It also helps to speed up the installation time.

4

SPECIFICATIONS

PUHZ-SW40VHA

PUHZ-SW50VHA

<Reference data> Plate heat exchanger (ACH50-50 plates) *2pcs [connected in parallel]

(SW40)

Nominal water flow		L/min	11.80
Heating (A7/W35)	Capacity	kW	4.10
	COP		4.80
	Power input	kW	0.85
Heating (A7/W45)	Capacity	kW	4.10
	COP		3.63
	Power input	kW	1.13
Heating (A2/W35)	Capacity	kW	4.00
	COP		3.24
	Power input	kW	1.24
Heating (A2/W45)	Capacity	kW	4.00
	COP		2.68
	Power input	kW	1.49
Nominal water flow		L/min	10.30
Cooling (A35/W7)	Capacity	kW	3.60
	EER		2.71
	Power input	kW	1.33
Cooling (A35/W18)	Capacity	kW	3.60
	EER		4.65
	Power input	kW	0.77

(SW50)

Nominal water flow		L/min	17.2
Heating (A7/W35)	Capacity	kW	6.00
	COP		4.42
	Power input	kW	1.36
Heating (A7/W45)	Capacity	kW	6.00
	COP		3.32
	Power input	kW	1.81
Heating (A2/W35)	Capacity	kW	5.00
	COP		2.97
	Power input	kW	1.68
Heating (A2/W45)	Capacity	kW	5.00
	COP		2.47
	Power input	kW	2.03
Nominal water flow		L/min	12.9
Cooling (A35/W7)	Capacity	kW	4.50
	EER		2.38
	Power input	kW	1.90
Cooling (A35/W18)	Capacity	kW	5.00
	EER		3.96
	Power input	kW	1.26

Note: "COP" and "Power input" in the above table are values that does **NOT** contains the "pump input (based on EN 14511)".



Rating conditions

Nominal operating condition	
Heating (A7/W35)	
Outside air temperature (Dry-bulb)	+ 7 °C
Outside air temperature (Wet-bulb)	+ 6 °C
Water temperature (inlet/outlet)	+ 30 °C/+ 35 °C
Heating (A7/W45)	
Outside air temperature (Dry-bulb)	+ 7 °C
Outside air temperature (Wet-bulb)	+ 6 °C
Water temperature (inlet/outlet)	+ 40 °C/+ 45 °C
Heating (A2/W35)	
Outside air temperature (Dry-bulb)	+ 2 °C
Outside air temperature (Wet-bulb)	+ 1 °C
Water temperature (inlet/outlet)	+ 30 °C/+ 35 °C
Heating (A2/W45)	
Outside air temperature (Dry-bulb)	+ 2 °C
Outside air temperature (Wet-bulb)	+ 1 °C
Water temperature (inlet/outlet)	+ 40 °C/+ 45 °C
Cooling (A35/W7)	
Outside air temperature (Dry-bulb)	+ 35 °C
Outside air temperature (Wet-bulb)	+ 24 °C
Water temperature (inlet/outlet)	+ 12 °C/+ 7 °C
Cooling (A35/W18)	
Outside air temperature (Dry-bulb)	+ 35 °C
Outside air temperature (Wet-bulb)	+ 24 °C
Water temperature (inlet/outlet)	+ 23 °C/+ 18 °C

Service Ref.		PUHZ-SW40VHA PUHZ-SW40VHA-BS		PUHZ-SW50VHA PUHZ-SW50VHA-BS	
OUTDOOR UNIT	Power supply (phase, cycle, voltage)	Single, 50Hz, 230V			
	Max. current	A	13		
	External finish	Munsell 3Y 7.8/1.1			
	Refrigerant control	Linear Expansion Valve			
	Compressor	Hermetic			
	Model	SNB130FGCM2			
	Motor output	kW	0.9		
	Starter type	Inverter			
	Protection devices	HP switch Comp.surface thermo Discharge thermo Over current detection			
	Crankcase heater	W	—		
	Heat exchanger	Plate fin coil			
	Fan	Fan(drive) × No.	Propeller fan × 1		
		Fan motor output	kW	0.040	
		Airflow	m³/min(CFM)	35(1,240)	
	Defrost method	Reverse cycle			
	Noise level	Cooling	dB	45	46
		Heating	dB	45	46
	Dimensions	W	mm(in.)	800(31-1/2)	
D		mm(in.)	300+23(11-13/16+7/8)		
H		mm(in.)	600(23-5/8)		
Weight		kg(lbs)	42(93)		
Refrigerant	R410A				
	Charge	kg(lbs)	2.1(4.6)		
	Oil (Model)	L	0.50(FV50S)		
REFRIGERANT PIPING	Pipe size O.D.	Liquid	mm(in.)	6.35(1/4)	
		Gas	mm(in.)	12.7(1/2)	
	Connection method	Indoor side	Flared		
		Outdoor side	Flared		
	Between the indoor & outdoor unit	Height difference	Max. 10m		
	Piping length	Max. 40m			

5

DATA

5-1. REFILLING REFRIGERANT CHARGE (R410A : kg)

Service Ref.	Piping length (one way)							Initial charged
	10m	20m	30m	40m	50m	60m	75m	
PUHZ-SW40VHA PUHZ-SW40VHA-BS	2.1	2.3	2.5	2.7	2.9	—	—	2.5
PUHZ-SW50VHA PUHZ-SW50VHA-BS	2.1	2.3	2.5	2.7	2.9	—	—	2.5

Additional charge is required for pipes longer than 10 m.

5-2. COMPRESSOR TECHNICAL DATA

(at 20°C)

Service Ref.	PUHZ-SW40VHA(-BS) PUHZ-SW50VHA(-BS)	
Compressor model	SNB130FGCM2	
Winding Resistance (Ω)	U-V	0.64
	U-W	0.64
	W-V	0.64

5-3. NOISE CRITERION CURVES

PUHZ-SW40VHA(-BS)

MODE	SPL(dB)	LINE
COOLING	45	○—○
HEATING	45	●—●

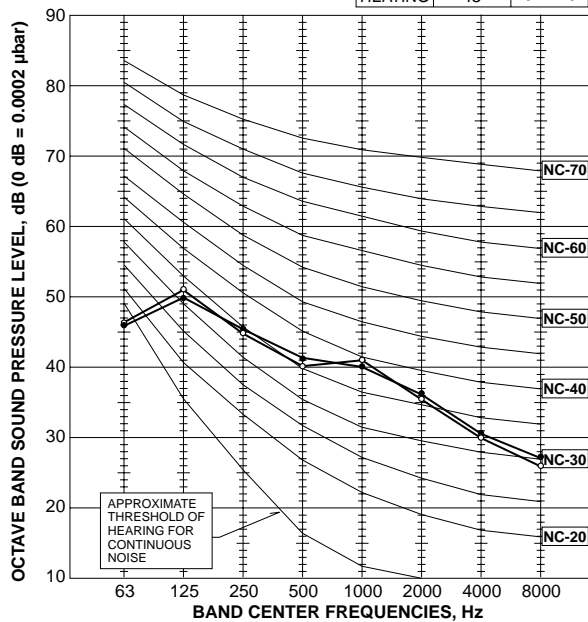

PUHZ-SW50VHA(-BS)

MODE	SPL(dB)	LINE
COOLING	46	○—○
HEATING	46	●—●

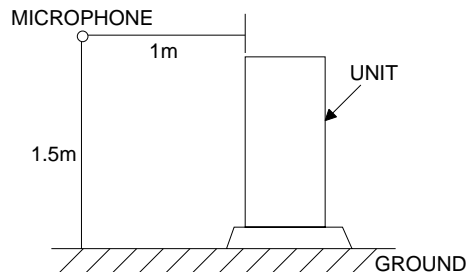
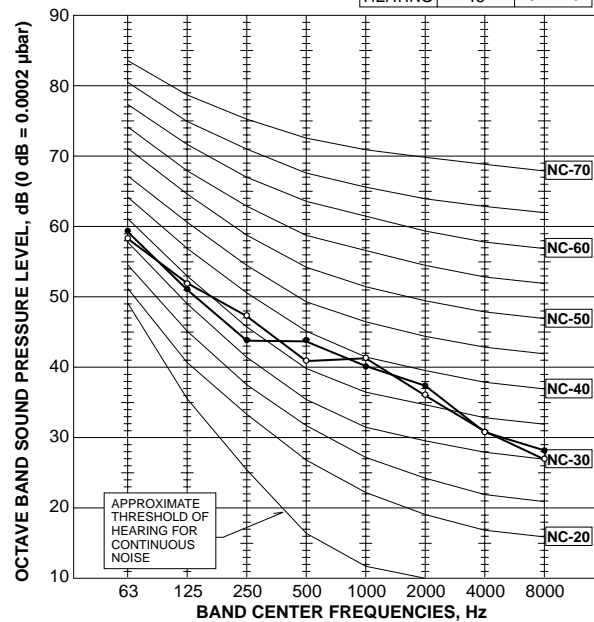

6

OUTLINES AND DIMENSIONS

PUHZ-SW40VHA
PUHZ-SW50VHA

PUHZ-SW40VHA-BS
PUHZ-SW50VHA-BS

Unit : mm

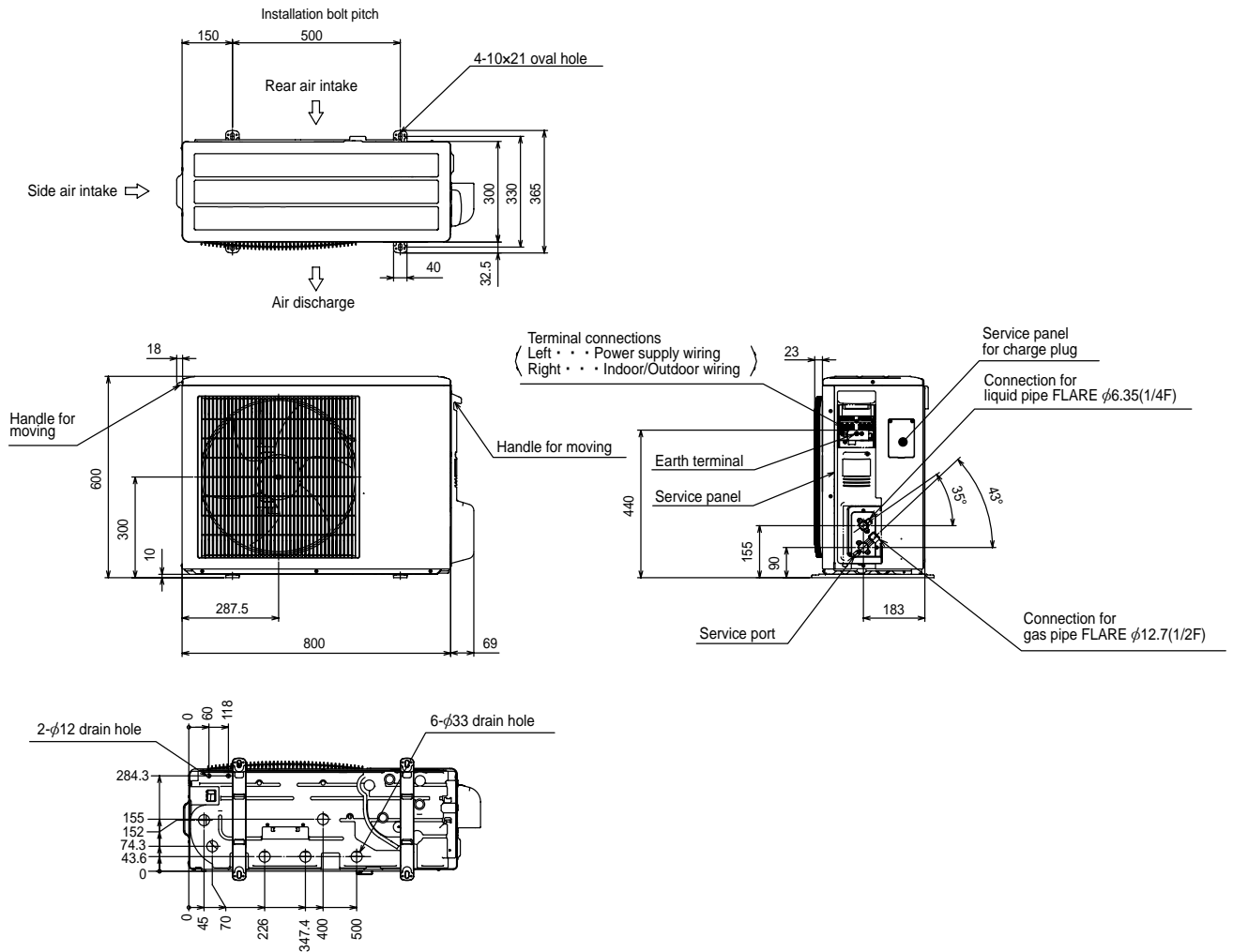

Free space around the outdoor unit (basic example)

100 mm or more as long as no obstacle is placed on the rear and right-and-left sides of the unit.

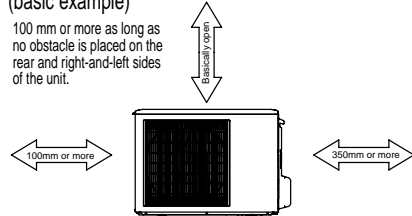

2 sides should be open in the right, left and rear side.

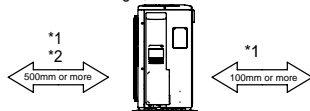

Minimum installation space for outdoor unit

- *1 In the place where short cycle tends to occur, cooling and heating capacity and power consumption might get lowered 10%. Air outlet guide (optional PAC-SG58SG) will help them improve.
- *2 If air discharges to the wall, the surface might get stained.

FOUNDATION BOLTS

Please secure the unit firmly with 4 foundation (M10) bolts. (Bolts, washers and nut must be purchased locally).

<Foundation bolt height>

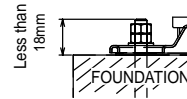

PIPING-WIRING DIRECTION

Piping and wiring connection can be made from the rear direction only.

PUHZ-SW40VHA
PUHZ-SW50VHA

PUHZ-SW40VHA-BS
PUHZ-SW50VHA-BS

SYMBOL	NAME	SYMBOL	NAME	SYMBOL	NAME
TB1	Terminal Block <Power Supply, Indoor/Outdoor>	P. B.	Power Circuit Board	SW5	Switch <Function Switch, Model Select>
MC	Motor for Compressor	R, S	Connection Terminal <L/N-Phase>	SW6	Switch <Model Select>
MF1	Fan Motor	U, V, W	Connection Terminal <U/V/W-Phase>	SW7	Switch <Function Switch>
21S4	Solenoid Valve (Four-Way Valve)	IPM	Power Module	SW8	Switch <Function Switch>
63H	High Pressure Switch	PFC	Converter	SW9	Switch <Function Switch>
63HS	High Pressure Sensor	CB1, CB2, CB3	Main Smoothing Capacitor	SWP	Switch <Pump Down>
TH3	Thermistor <Liquid>	N. F.	Noise Filter Circuit Board	CN31	Connector <Emergency Operation>
TH4	Thermistor <Discharge>	LI, LO	Connection Terminal <L-Phase>	CNDM	Connector <Connection for Option>
TH6	Thermistor <2-Phase Pipe>	NI, NO	Connection Terminal <N-Phase>	CN51	Connector <Connection for Option>
TH7	Thermistor <Ambient>	E1, E2, E3	Connection Terminal <Ground>	SV1/CH	Connector <Connection for Option>
TH8	Thermistor <Heat Sink>	52C	52C Relay	SS	Connector <Connection for Option>
TH34	Thermistor <Comp. Surface>	C. B.	Controller Circuit Board	CNM	Connector <Connection for Option>
LEV-A, LEV-B	Linear Expansion Valve	SW1	Switch <Manual Defrost, Defect History, Record Reset, Refrigerant Address>	LED1, LED2	LED <Operation Inspection Indicators>
ACL	Reactor	SW4	Switch <Test Operation>	F1, F2, F3, F4	Fuse <T6.3AL250V>
CY1, CY2	Capacitor			X51, X52, X54	Relay

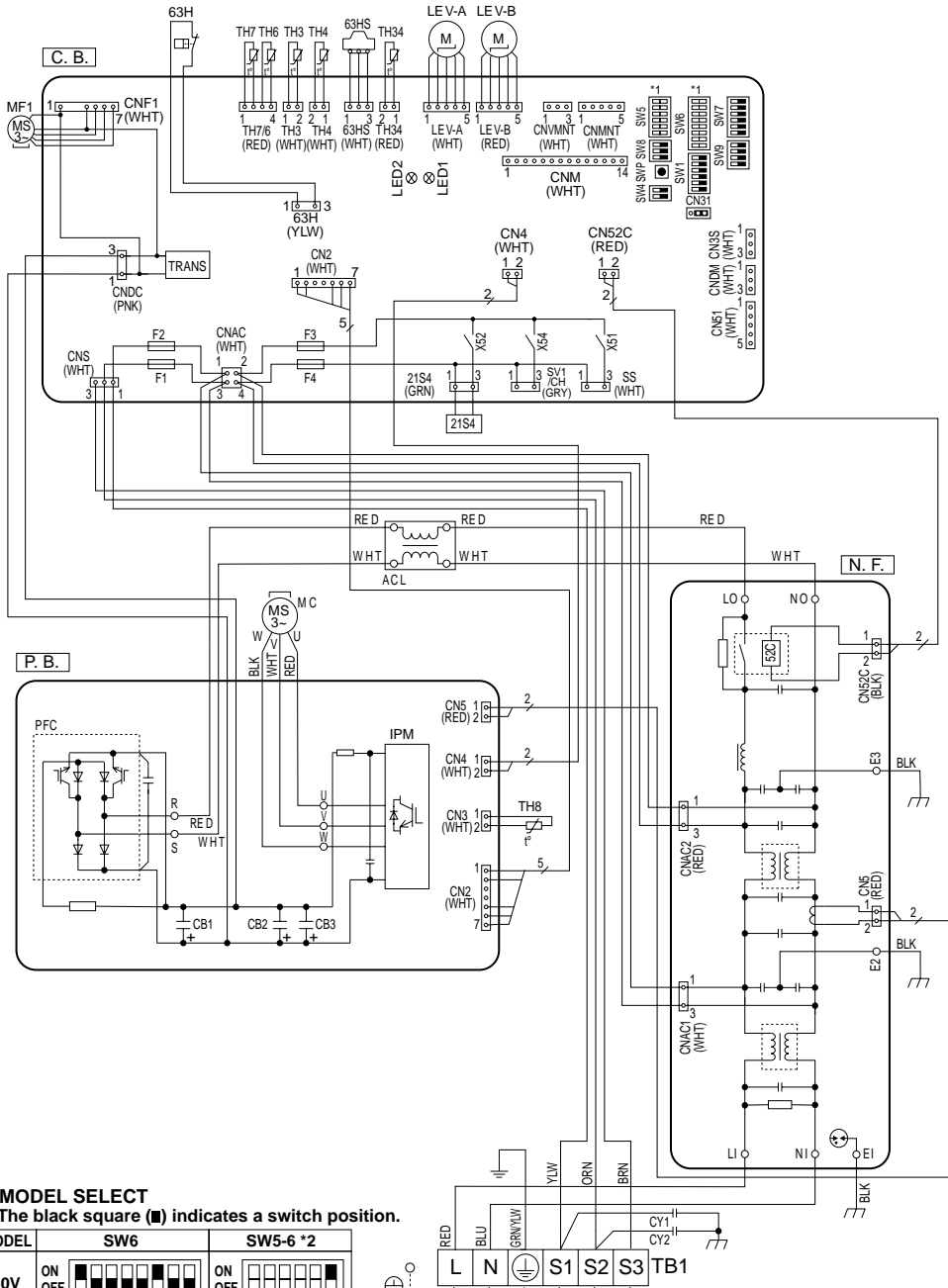

*1 MODEL SELECT
The black square (■) indicates a switch position.

MODEL	SW6	SW5-6 *2
40V	ON OFF	ON OFF
50V	ON OFF	ON OFF

*2 SW5 -1 to 5 : Function Switch

OCH525

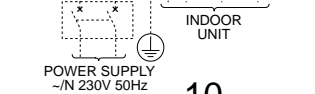

8-1. FIELD ELECTRICAL WIRING (power wiring specifications)

Outdoor unit model		SW40, 50V
Outdoor unit power supply		~N (single), 50 Hz, 230 V
Outdoor unit input capacity Main switch (Breaker)		*1 16 A
Wiring Wire No. x size (mm ²)	Outdoor unit power supply	3 x Min. 1.5
	Indoor unit-Outdoor unit	3 x 1.5 (Polar)
	Indoor unit-Outdoor unit earth	1 x Min. 1.5
	Remote controller-Indoor unit	2 x 0.3 (Non-polar)
Circuit rating	Outdoor unit L-N (single)	*4 AC 230 V
	Outdoor unit L1-N, L2-N, L3-N (3 phase)	*4 AC 230 V
	Indoor unit-Outdoor unit S1-S2	*4 AC 230 V
	Indoor unit-Outdoor unit S2-S3	*4 DC 24 V
	Remote controller-Indoor unit	*4 DC 12 V

- *1. A breaker with at least 3.0 mm contact separation in each poles shall be provided. Use earth leakage breaker (NV). Make sure that the current leakage breaker is one compatible with higher harmonics. Always use a current leakage breaker that is compatible with higher harmonics as this unit is equipped with an inverter. The use of inadequate breaker can cause the incorrect operation of inverter.
- *2. Max. 45 m
If 2.5 mm² used, Max. 50 m
If 2.5 mm² used and S3 separated, Max. 80 m
- *3. The 10 m wire is attached in the remote controller accessory.
- *4. The figures are NOT always against the ground.
S3 terminal has DC 24 V against S2 terminal. However between S3 and S1, these terminals are NOT electrically insulated by the transformer or other device.

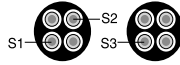

⚠ Caution: Be sure to install N-Line. Without N-Line, it could cause damage to the unit.

- Notes:**
1. Wiring size must comply with the applicable local and national code.
 2. Power supply cables and Indoor/Outdoor unit connecting cables shall not be lighter than polychloroprene sheathed flexible cable. (Design 60245 IEC 57)
 3. Install an earth longer than other cables.

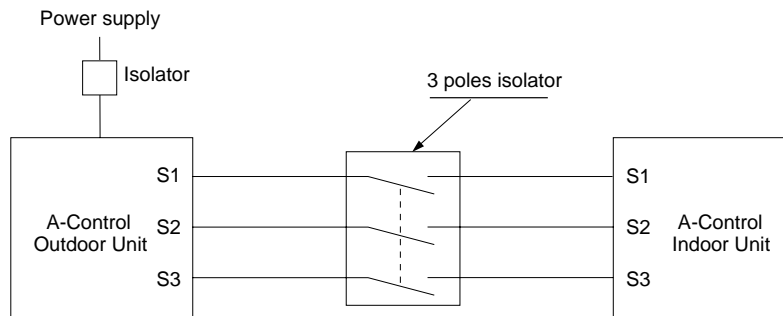

⚠ Warning:

In case of A-control wiring, there is high voltage potential on the S3 terminal caused by electrical circuit design that has no electrical insulation between power line and communication signal line. Therefore, please turn off the main power supply when servicing. And do not touch the S1, S2, S3 terminals when the power is energized. If isolator should be used between indoor unit and outdoor unit, please use 3-pole type.

PUHZ-SW40VHA
PUHZ-SW50VHA

PUHZ-SW40VHA-BS
PUHZ-SW50VHA-BS

Unit : mm (inch)

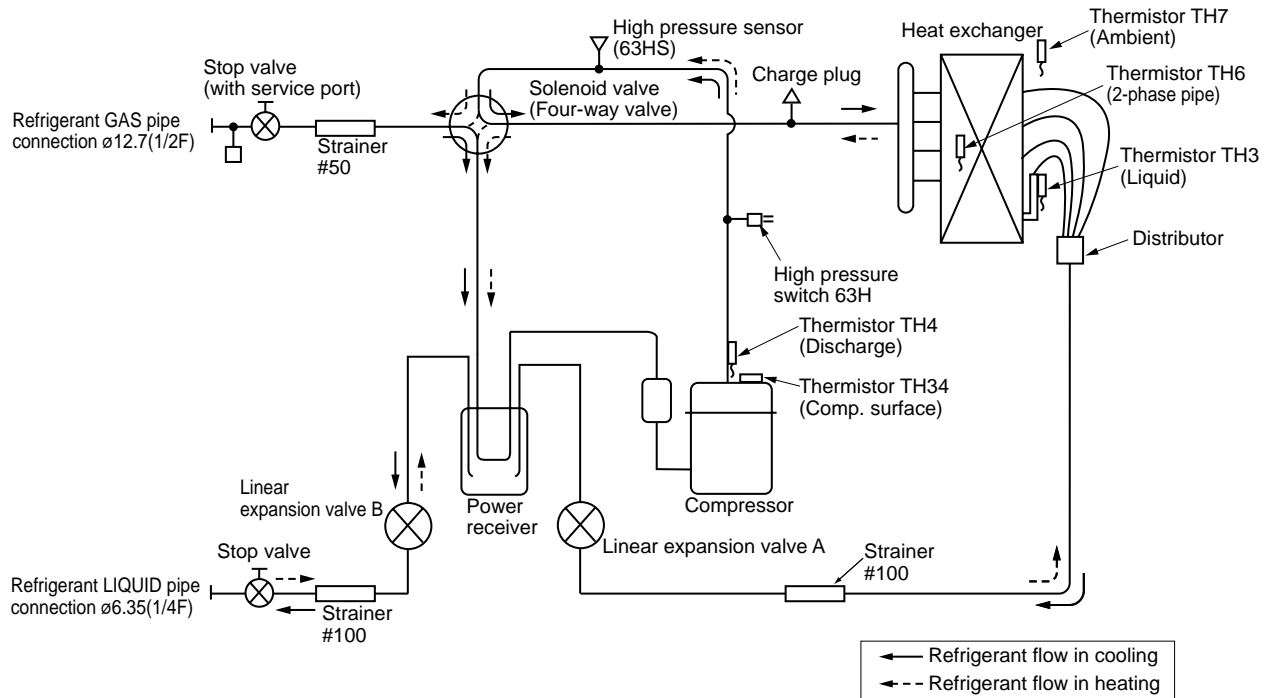

Symbol	Part name	Detail
COMP	Compressor	DC inverter twin rotary compressor (Mitsubishi Electric Corporation)
H/P SW	High pressure switch (63H)	For protection (OFF:4.15MPa)
REV/V	Reversing (4-way) valve (21S4)	Change the refrigerant circuit (Heating / Cooling) and for Defrosting
Charge plug	Charge plug	High pressure / Low pressure / For production test use
P-Sensor	High pressure sensor (63HS)	For calculation of the condensing temperature from high pressure
LEV-A	Linear expansion valve -A	Heating:Secondary LEV Cooling:Primary LEV
LEV-B	Linear expansion valve -B	Heating:Primary LEV Cooling:Secondary LEV
TH3	Liquid temperature thermistor	Heating:Evaporating temperature Cooling:Sub cool liquid temperature
TH4	Discharge temperature thermistor	For LEV control and for compressor protection
TH6	2-phase pipe temperature thermistor	Outdoor 2-phase pipe temperature
TH7	Ambient temperature thermistor	For fan control and for compressor frequency control
TH34	Comp.surface temperature thermistor	For compressor protection
Power Receiver	Power Receiver	For accumulation of refrigerant



9-1. Refrigerant collecting (pump down)

Perform the following procedures to collect the refrigerant when moving the indoor unit or the outdoor unit.

- ① Supply power (circuit breaker).
 - * When power is supplied, make sure that “CENTRALLY CONTROLLED” is not displayed on the remote controller. If “CENTRALLY CONTROLLED” is displayed, the refrigerant collecting (pump down) cannot be completed normally.
 - * Start-up of the indoor-outdoor communication takes about 3 minutes after the power (circuit breaker) is turned on. Start the pump-down operation 3 to 4 minutes after the power (circuit breaker) is turned ON.
 - * In the case of multi-units control, before powering on, disconnect the wiring between the master indoor unit and the slave indoor unit. For more details refer to the installation manual for the indoor unit.
- ② After the liquid stop valve is closed, set the SWP switch on the control board of the outdoor unit to ON. The compressor (outdoor unit) and ventilators (indoor and outdoor units) start operating and refrigerant collecting operation begins. LED1 and LED2 on the control board of the outdoor unit are lit.
 - * Only set the SWP switch (push-button type) to ON if the unit is stopped. However, even if the unit is stopped and the SWP switch is set to ON less than 3 minutes after the compressor stops, the refrigerant collecting operation cannot be performed. Wait until compressor has been stopped for 3 minutes and then set the SWP switch to ON again.
- ③ Because the unit automatically stops in about 2 to 3 minutes when the refrigerant collecting operation is completed (LED1 off, LED2 lit), be sure to quickly close the gas stop valve. If LED1 is lit and LED2 is off and the outdoor unit is stopped, refrigerant collection is not properly performed. Open the liquid stop valve completely, and then repeat step ② after 3 minutes have passed.
 - * If the refrigerant collecting operation has been completed normally (LED1 off, LED2 lit), the unit will remain stopped until the power supply is turned off.
- ④ Turn off the power supply (circuit breaker).
 - * Note that when the extension piping is very long with large refrigerant amount, it may not be possible to perform a pump-down operation. When performing the pump-down operation, make sure that the low pressure is lowered to near 0 MPa (gauge).

⚠ Warning:

When pumping down the refrigerant, stop the compressor before disconnecting the refrigerant pipes. The compressor may burst if air etc. get into it.

9-2. Start and finish of test run

- Operation from the indoor unit
Execute the test run using the installation manual for the indoor unit.
- Operation from the outdoor unit
By using the DIP switch SW4 on the control board of outdoor unit, test run can be started and finished, and its operation mode (cooling/heating) can be set up.

- ① Set the operation mode (cooling/heating) using SW4-2.
- ② Turn on SW4-1 to start test run with the operation mode set by SW4-2.
- ③ Turn off SW4-1 to finish the test run.

- There may be a faint knocking sound around the machine room after power is supplied, but this is no problem with product because the linear expansion pipe is just moving to adjust opening pulse.
- There may be a knocking sound around the machine room for several seconds after compressor starts operating, but this is no problem with product because the check valve itself, generates the sound because pressure difference is small in the refrigerant circuit.

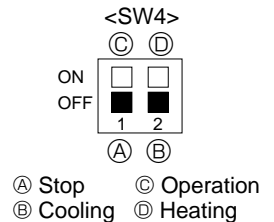

Note:

The operation mode cannot be changed by SW4-2 during test run. (To change test run mode, stop the unit by SW4-1, change the operation mode and restart the test run by SW4-1.)

10-1. TROUBLESHOOTING

<Error code display by self-diagnosis and actions to be taken for service (summary)>

Present and past error codes are logged and displayed on the control board of outdoor unit. Actions to be taken for service, which depends on whether or not the trouble is reoccurring at service, are summarized in the table below. Check the contents below before investigating details.

Unit conditions at service	Error code	Actions to be taken for service (summary)
The trouble is reoccurring.	Displayed	Judge what is wrong and take a corrective action according to "10-3. Self-diagnosis action table".
	Not displayed	Conduct troubleshooting and ascertain the cause of the trouble.
The trouble is not reoccurring.	Logged	① Consider the temporary defects such as the work of protection devices in the refrigerant circuit including compressor, poor connection of wiring, noise and etc. Re-check the symptom, and check the installation environment, refrigerant amount, weather when the trouble occurred, matters related to wiring and etc. ② Reset error code logs and restart the unit after finishing service. ③ There is no abnormality in electrical component, controller board, and etc.
	Not logged	① Re-check the abnormal symptom. ② Conduct troubleshooting and ascertain the cause of the trouble. ③ Continue to operate unit for the time being if the cause is not ascertained. ④ There is no abnormality concerning of parts such as electrical component, controller board, and etc.

10-2. CHECK POINT UNDER TEST RUN

Before test run

- After installation of outdoor unit, piping work and electric wiring work, re-check that there is no water leakage, loosened connections and incorrect polarity.
- Measure impedance between the ground and the power supply terminal block (L, N) on the outdoor unit by 500 V Megger and check that it is 1.0 MΩ or over.
- Turn on power supply 12 hours before test run in order to protect compressor.
- Make sure to read operation manual before test run. (Especially items to secure safety.)

Warning:

Do not use the system if the insulation resistance is less than 1.0 MΩ.

Caution:

Do not carry out this test on the control wiring (low voltage circuit) terminals.

10-3. SELF-DIAGNOSIS ACTION TABLE

<Abnormalities detected when the power is put on>

(Note 1) Refer to indoor unit section for code P and code E.

Error Code	Abnormal points and detection method	Case	Judgment and action
None	—	<p>① No voltage is supplied to terminal block (TB1) of outdoor unit. a) Power supply breaker is turned off. b) Contact failure or disconnection of power supply terminal c) Open phase (L or N phase)</p> <p>② Electric power is not supplied to power supply terminal of outdoor power circuit board. a) Contact failure of power supply terminal b) Open phase on the outdoor power circuit board (Disconnection of terminal on outdoor power circuit board)</p> <p>③ Electric power is not supplied to outdoor controller circuit board. a) Disconnection of connector (CNDC)</p> <p>④ Disconnection of reactor (ACL)</p> <p>⑤ Disconnection of outdoor noise filter circuit board or parts failure in outdoor noise filter circuit board</p> <p>⑥ Defective outdoor power circuit board</p> <p>⑦ Defective outdoor controller circuit board</p>	<p>① Check following items. a) Power supply breaker b) Connection of power supply terminal block. (TB1) c) Connection of power supply terminal block. (TB1)</p> <p>② Check following items. a) Connection of power supply terminal block. (TB1) b) Connection of terminal on outdoor power circuit board.</p> <p>③ Check connection of the connector (CNDC) on the outdoor controller circuit board. Check connection of the connector, LD1 and LD2 on the outdoor power circuit board. Refer to 10-9.</p> <p>④ Check connection of reactor. (ACL) Check connection of "LO" and "NO" on the outdoor noise filter circuit board. Check connection of "R" and "S" on the outdoor power circuit board. Refer to 10-9.</p> <p>⑤ a) Check connection of outdoor noise filter circuit board. b) Replace outdoor noise filter circuit board. Refer to 10-9.</p> <p>⑥ Replace outdoor power circuit board.</p> <p>⑦ Replace controller board (When items above are checked but the units can not be repaired.)</p>
F5	<p>63H connector open Abnormal if 63H connector circuit is open for 3 minutes continuously after power supply. 63H: High-pressure switch</p>	<p>① Disconnection or contact failure of 63H connector on outdoor controller circuit board</p> <p>② Disconnection or contact failure of 63H</p> <p>③ 63H is working due to defective parts.</p> <p>④ Defective outdoor controller circuit board</p>	<p>① Check connection of 63H connector on outdoor controller circuit board. Refer to 10-9.</p> <p>② Check the 63H side of connecting wire.</p> <p>③ Check continuity by tester. Replace the parts if the parts are defective.</p> <p>④ Replace outdoor controller circuit board.</p>



Error Code	Abnormal points and detection method	Case	Judgment and action
EA	<p>Miswiring of indoor/outdoor unit connecting wire</p> <p>1. Outdoor controller circuit board can automatically check the number of connected indoor units. Abnormal if the number cannot be checked automatically due to miswiring of indoor/outdoor unit connecting wire and etc. after power is turned on for 4 minutes.</p> <p>2. Abnormal if outdoor controller circuit board recognizes excessive number of indoor units.</p>	<p>① Contact failure or miswiring of indoor/outdoor unit connecting wire</p> <p>② Diameter or length of indoor/outdoor unit connecting wire is out of specified capacity.</p> <p>③ Excessive number of indoor units are connected to 1 outdoor unit. (4 units or more)</p> <p>④ Defective transmitting receiving circuit of outdoor controller circuit board</p> <p>⑤ Defective transmitting receiving circuit of indoor controller board</p> <p>⑥ Defective indoor power board</p> <p>⑦ 2 or more outdoor units have refrigerant address "0" . (In case of group control)</p> <p>⑧ Noise has entered into power supply or indoor / outdoor unit connecting wire.</p>	<p>① Check disconnection or looseness or polarity of indoor/outdoor unit connecting wire of indoor and outdoor units.</p> <p>② Check diameter and length of indoor/outdoor unit connecting wire. Total wiring length: 80 m (including wiring connecting each indoor unit and between indoor and outdoor unit) Also check if the connection order of flat cable is S1, S2, S3.</p> <p>③ Check the number of indoor units that are connected to one outdoor unit. (If EA is detected)</p> <p>④~⑥ Turn the power off once, and on again to check. Replace outdoor controller circuit board, indoor controller board or indoor power board if abnormality occurs again.</p> <p>⑦ Check if refrigerant addresses (SW1-3 to SW1-6 on outdoor controller circuit board) are overlapping in case of group control system.</p>
Eb	<p>Miswiring of indoor/outdoor unit connecting wire (converse wiring or disconnection)</p> <p>Outdoor controller circuit board can automatically set the unit number of indoor units. Abnormal if the indoor unit number can not be set within 4 minutes after power on because of Miswiring (converse wiring or disconnection) of indoor/outdoor unit connecting wire.</p>	<p>① Contact failure or miswiring of indoor/outdoor unit connecting wire</p> <p>② Diameter or length of indoor/outdoor unit connecting wire is out of specified capacity.</p> <p>④ Defective transmitting receiving circuit of outdoor controller circuit board</p> <p>⑤ Defective transmitting receiving circuit of indoor controller board</p> <p>⑥ Defective indoor power board</p> <p>⑦ 2 or more outdoor units have refrigerant address "0" . (In case of group control)</p> <p>⑧ Noise has entered into power supply or indoor/outdoor unit connecting wire.</p>	<p>⑧ Check transmission path, and remove the cause.</p> <p>* The descriptions above, ①-⑧, are for EA, Eb and EC.</p>
EC	<p>Start-up time over</p> <p>The unit cannot finish start-up process within 4 minutes after power on.</p>	<p>① Contact failure of indoor/outdoor unit connecting wire</p> <p>② Diameter or length of indoor/outdoor unit connecting wire is out of specified capacity.</p> <p>⑦ 2 or more outdoor units have refrigerant address "0" . (In case of group control)</p> <p>⑧ Noise has entered into power supply or indoor/outdoor unit connecting wire.</p>	
EE	<p>Incorrect connection</p> <p>The outdoor unit does not receive the signals of I/F or FTC.</p>	<p>① A device other than Interface unit or Flow temp. controller unit is connected to the unit.</p>	<p>① Connect I/F or FTC to the unit.</p>

<Abnormalities detected while unit is operating>

Error Code	Abnormal points and detection method	Case	Judgment and action
U1	<p>High pressure (High-pressure switch 63H operated) Abnormal if high-pressure switch 63H operated (*) during compressor operation. * SW40,50 (63H) : 4.15 MPa</p> <p>63H: High-pressure switch</p>	<p>① Short cycle of indoor unit ② Clogged filter of indoor unit ③ Decreased airflow caused by dirt of indoor fan ④ Dirt of indoor heat exchanger ⑤ Locked indoor fan motor ⑥ Malfunction of indoor fan motor ⑦ Defective operation of stop valve (Not full open) ⑧ Clogged or broken pipe ⑨ Locked outdoor fan motor ⑩ Malfunction of outdoor fan motor ⑪ Short cycle of outdoor unit ⑫ Dirt of outdoor heat exchanger ⑬ Decreased airflow caused by defective inspection of outside temperature thermistor (It detects lower temperature than actual temperature.) ⑭ Disconnection or contact failure of connector (63H) on outdoor controller board ⑮ Disconnection or contact failure of 63H connection ⑯ Defective outdoor controller board ⑰ Defective action of linear expansion valve ⑱ Malfunction of fan driving circuit</p>	<p>①~⑥ Check indoor unit and repair defect.</p> <p>⑦ Check if stop valve is fully open.</p> <p>⑧ Check piping and repair defect. ⑨~⑫ Check outdoor unit and repair defect.</p> <p>⑬ Check the detected temperature of outside temperature thermistor on LED display. (SW2 on A-Control Service Tool : Refer to 10-10.)</p> <p>⑭~⑯ Turn the power off and check F5 is displayed when the power is turned again. When F5 is displayed, refer to "Judgment and action" for F5.</p> <p>⑰ Check linear expansion valve. Refer to 10-6. ⑱ Replace outdoor controller board.</p>
U2	<p>High discharging temperature (1) Abnormal if discharge temperature thermistor (TH4) exceeds 125°C or 110°C continuously for 5 minutes. Abnormal if discharge temperature thermistor (TH4) exceeds 110°C or more continuously for 30 seconds after 90 seconds have passed since the defrosting operation started.</p> <p>(2) Abnormal if discharge superheat (Cooling: TH4 – T_{63HS} / Heating: TH4 – T_{63HS}) exceeds 70°C continuously for 10 minutes.</p> <p>High comp. surface temperature Abnormal if comp. surface temperature (TH34) exceeds 125°C. In the case of high comp. surface temperature error, compressor does not restart unless the thermistor (TH34) becomes less than 95°C.</p>	<p>① Overheated compressor operation caused by shortage of refrigerant ② Defective operation of stop valve ③ Defective thermistor ④ Defective outdoor controller board ⑤ Defective action of linear expansion valve ⑥ Clogging with foreign objects in refrigerant circuit * Clogging occur in the parts which become below freezing point when water enters in refrigerant circuit.</p>	<p>① Check intake superheat. Check leakage of refrigerant. Charge additional refrigerant. ② Check if stop valve is fully open.</p> <p>③④ Turn the power off and check if U3 is displayed when the power is turned on again. When U3 is displayed, refer to "Judgement and action" for U3. ⑤ Check linear expansion valve. Refer to 10-6. ⑥ After recovering refrigerant, remove water from entire refrigerant circuit under vacuum more than 1 hour.</p>
U3	<p>Open/short circuit of discharge temperature thermistor (TH4) / comp. surface thermistor (TH34) Abnormal if open (3°C or less) or short (217°C or more) is detected during compressor operation. (Detection is inoperative for 10 minutes of compressor starting process and for 10 minutes after and during defrosting.)</p>	<p>① Disconnection or contact failure of connector (TH4/TH34) on the outdoor controller circuit board ② Defective thermistor ③ Defective outdoor controller circuit board</p>	<p>① Check connection of connector (TH4/TH34) on the outdoor controller circuit board. Check breaking of the lead wire for thermistor (TH4/TH34). Refer to 10-9. ② Check resistance value of thermistor (TH4/TH34) or temperature by microcomputer. (Thermistor/TH4/TH34: Refer to 10-6.) (SW2 on A-Control Service Tool: Refer to 10-10.) ③ Replace outdoor controller board.</p>



Error Code	Abnormal points and detection method	Case	Judgment and action																						
U4	<p>Open/short of outdoor unit thermistors (TH3, TH6, TH7, and TH8) Abnormal if open or short is detected during compressor operation. Open detection of thermistors TH3 and TH6 is inoperative for 10 seconds to 10 minutes after compressor starting and 10 minutes after and during defrosting. * Check which unit has abnormality in its thermistor by switching the mode of SW2. (PAC-SK52ST) (Refer to 10-10.)</p>	<p>① Disconnection or contact failure of connectors (Outdoor controller circuit board: TH3, TH6/TH7 Outdoor power circuit board: CN3) ② Defective thermistor ③ Defective outdoor controller circuit board</p>	<p>① Check connection of connector (TH3, TH6/TH7) on the outdoor controller circuit board. Check connection of connector (CN3) on the outdoor power circuit board. Check breaking of the lead wire for thermistor (TH3, TH6, TH7, TH8). Refer to 10-9. ② Check resistance value of thermistor (TH3, TH6, TH7, TH8) or check temperature by microcomputer. (Thermistor/TH3, TH6, TH7, TH8: Refer to 10-6.) (SW2 on A-Control Service Tool: Refer to 10-10.) ③ Replace outdoor controller circuit board.</p>																						
	<table border="1" style="width: 100%; border-collapse: collapse;"> <thead> <tr> <th colspan="2">Thermistors</th> <th rowspan="2">Open detection</th> <th rowspan="2">Short detection</th> </tr> <tr> <th>Symbol</th> <th>Name</th> </tr> </thead> <tbody> <tr> <td>TH3</td> <td>Thermistor <Liquid></td> <td>- 40 °C or below</td> <td>90 °C or above</td> </tr> <tr> <td>TH6</td> <td>Thermistor <2-phase pipe></td> <td>- 40 °C or below</td> <td>90 °C or above</td> </tr> <tr> <td>TH7</td> <td>Thermistor <Ambient></td> <td>- 40 °C or below</td> <td>90 °C or above</td> </tr> <tr> <td>TH8</td> <td>Thermistor <Heatsink></td> <td>- 27 °C or below</td> <td>102 °C or above</td> </tr> </tbody> </table>				Thermistors		Open detection	Short detection	Symbol	Name	TH3	Thermistor <Liquid>	- 40 °C or below	90 °C or above	TH6	Thermistor <2-phase pipe>	- 40 °C or below	90 °C or above	TH7	Thermistor <Ambient>	- 40 °C or below	90 °C or above	TH8	Thermistor <Heatsink>	- 27 °C or below
Thermistors		Open detection	Short detection																						
Symbol	Name																								
TH3	Thermistor <Liquid>	- 40 °C or below	90 °C or above																						
TH6	Thermistor <2-phase pipe>	- 40 °C or below	90 °C or above																						
TH7	Thermistor <Ambient>	- 40 °C or below	90 °C or above																						
TH8	Thermistor <Heatsink>	- 27 °C or below	102 °C or above																						
U5	<p>Temperature of heatsink Abnormal if heatsink thermistor (TH8) detects temperature indicated below. SW40/50..... 84°C</p>	<p>① The outdoor fan motor is locked. ② Failure of outdoor fan motor ③ Air flow path is clogged. ④ Rise of ambient temperature ⑤ Defective thermistor ⑥ Defective input circuit of outdoor power circuit board ⑦ Failure of outdoor fan drive circuit</p>	<p>①② Check outdoor fan. ③ Check air flow path for cooling. ④ Check if there is something which causes temperature rise around outdoor unit. (Upper limit of ambient temperature is 46°C.) Turn off power, and on again to check if U5 is displayed within 30 minutes. If U4 is displayed instead of U5, follow the action to be taken for U4. ⑤ Check resistance value of thermistor (TH8) or temperature by microcomputer. (Thermistor/TH8: Refer to 10-6.) (SW2 on A-Control Service Tool: Refer to 10-10.) ⑥ Replace outdoor power circuit board. ⑦ Replace outdoor controller circuit board.</p>																						
U6	<p>Power module Check abnormality by driving power module in case overcurrent is detected. (UF or UP error condition)</p>	<p>① Outdoor stop valve is closed. ② Decrease of power supply voltage ③ Looseness, disconnection or converse of compressor wiring connection ④ Defective compressor ⑤ Defective outdoor power circuit board</p>	<p>① Open stop valve. ② Check facility of power supply. ③ Correct the wiring (U-V-W phase) to compressor. Refer to 10-9 (Outdoor power circuit board). ④ Check compressor referring to 10-6. ⑤ Replace outdoor power circuit board.</p>																						
U7	<p>Too low superheat due to low discharge temperature Abnormal if discharge superheat is continuously detected less than or equal to -15°C for 3 minutes even though linear expansion valve has minimum open pulse after compressor starts operating for 10 minutes.</p>	<p>① Disconnection or loose connection of discharge temperature thermistor (TH4) ② Defective holder of discharge temperature thermistor ③ Disconnection or loose connection of linear expansion valve's coil ④ Disconnection or loose connection of linear expansion valve's connector ⑤ Defective linear expansion valve</p>	<p>①② Check the installation conditions of discharge temperature thermistor (TH4). ③ Check the coil of linear expansion valve. Refer to 10-8. ④ Check the connection or contact of LEV-A and LEV-B on outdoor controller circuit board. ⑤ Check linear expansion valve. Refer to 10-6.</p>																						
U8	<p>Outdoor fan motor Abnormal if rotational frequency of the fan motor is not detected during DC fan motor operation. Fan motor rotational frequency is abnormal if; • 100 rpm or below detected continuously for 15 seconds at 20°C or more outside air temperature. • 50 rpm or below or 1500 rpm or more detected continuously for 1 minute.</p>	<p>① Failure in the operation of the DC fan motor ② Failure in the outdoor circuit controller board</p>	<p>① Check or replace the DC fan motor. ② Check the voltage of the outdoor circuit controller board during operation. ③ Replace the outdoor circuit controller board. (when the failure is still indicated even after performing the action ① above.)</p>																						



Error Code	Abnormal point and detection method	Case	Judgment and action	
U9	Detailed codes	To find out the details about U9 error, turn ON SW2-1, 2-2, 2-3, 2-4, 2-5 and 2-6 when U9 error occurs. To find out the detail history (latest) about U9 error, turn ON SW2-1, 2-2 and 2-6. Refer to 10-10.		
	01	Overvoltage error • Increase in DC bus voltage to 420V	① Abnormal increase in power source voltage ② Disconnection of compressor wiring ③ Defective outdoor power circuit board ④ Compressor has a ground fault.	① Check the field facility for the power supply. ② Correct the wiring (U-V-W phase) to compressor. Refer to 10-9 (Outdoor power circuit board). ③ Replace outdoor power circuit board. ④ Check compressor for electrical insulation. Replace compressor.
	02	Undervoltage error • Instantaneous decrease in DC bus voltage to 200V	① Decrease in power source voltage, instantaneous stop. ② Disconnection or loose connection of CN52C on the outdoor noise filter circuit board/controller circuit board ③ Defective converter drive circuit in outdoor power circuit board ④ Defective 52C drive circuit in outdoor noise filter circuit board	① Check the field facility for the power supply. ② Check CN52C wiring. ③ Replace outdoor power circuit board. ④ Replace outdoor noise filter circuit board.
	04	Input current sensor error • Decrease in input current through outdoor unit to 0.1A only if operation frequency is more than or equal to 40Hz or compressor current is more than or equal to 6A.	① Disconnection or loose connection of CN5 on the outdoor power circuit board/CNCT on the outdoor noise filter board ② Defective ACCT (AC current trans) on the outdoor noise filter circuit board ③ Defective input current detection circuit in outdoor power circuit board ④ Defective outdoor controller circuit board	① Check CN5/CNCT wiring. ② Replace outdoor noise filter circuit board. ③ Replace outdoor power circuit board. ④ Replace outdoor controller circuit board.
	08	Abnormal power synchronous signal • No input of power synchronous signal to power circuit board • Power synchronous signal of 44 Hz or less, or 65 Hz or more is detected on power circuit board.	① Distortion of power source voltage, Noise superimposition. ② Disconnection or loose connection of earth wiring ③ Disconnection or loose connection of CN2 on the outdoor power circuit board /controller circuit board ④ Defective power synchronous signal circuit in outdoor controller circuit board ⑤ Defective power synchronous signal circuit in outdoor power circuit board	① Check the field facility for the power supply. ② Check earth wiring. ③ Check CN2 wiring. ④ Replace outdoor controller circuit board. ⑤ Replace outdoor power circuit board.
	10	PFC error (Overvoltage/Undervoltage/Overcurrent) • PFC detected any of the followings a) Increase of DC bus voltage to 420V. b) Decrease in PFC control voltage to 12V DC or lower c) Increase in input current to 50A peak	① Abnormal increase in power source voltage ② Decrease in power source voltage, instantaneous stop ③ Disconnection of compressor wiring ④ Misconnection of reactor (ACL) ⑤ Defective outdoor power circuit board ⑥ Defective reactor (ACL) ⑦ Disconnection or loose connection of CN2 on the outdoor power circuit board/controller circuit board	①② Check the field facility for the power supply. ③ Correct the wiring (U-V-W phase) to compressor. Refer to 10-9 (Outdoor power circuit board). ④ Correct the wiring of reactor (ACL). ⑤ Replace outdoor power circuit board. ⑥ Replace reactor (ACL). ⑦ Check CN2 wiring.
	20	PFC/IGBT error (Undervoltage) • When compressor is running, DC bus voltage stays at 310V or lower for consecutive 10 seconds	① Incorrect switch settings on the outdoor controller circuit board for model select ② Defective outdoor power circuit board ③ Defective outdoor controller circuit board	① Correction of a model select ② Replace outdoor power circuit board. ③ Replace outdoor controller circuit board.



Error Code	Abnormal points and detection method	Case	Judgment and action
Ud	Over heat protection Abnormal if liquid thermistor (TH3) detects 70°C or more during compressor operation.	<ol style="list-style-type: none"> ① Defective outdoor fan (fan motor) or short cycle of outdoor unit during cooling operation ② Defective liquid thermistor (TH3) ③ Defective outdoor controller board 	<ol style="list-style-type: none"> ① Check outdoor unit air passage. ②③ Turn the power off and on again to check the error code. If U4 is displayed, follow the U4 processing direction.
UE	Abnormal pressure of pressure sensor (63HS) Abnormal if pressure sensor (63HS) detects 0.1 MPa or less. Detection is inoperative for 3 minutes after compressor starting and 3 minutes after and during defrosting.	<ol style="list-style-type: none"> ① Disconnection or contact failure of connector (63HS) on the outdoor controller circuit board ② Defective pressure sensor ③ Defective outdoor controller circuit board 	<ol style="list-style-type: none"> ① Check connection of connector (63HS) on the outdoor controller circuit board. Check breaking of the lead wire for thermistor (63HS). ② Check pressure by microprocessor. (Pressure sensor/ 63HS) (SW2: Refer to 10-10.) ③ Replace outdoor controller board.
UF	Compressor overcurrent interruption (When compressor locked) Abnormal if overcurrent of DC bus or compressor is detected within 30 seconds after compressor starts operating.	<ol style="list-style-type: none"> ① Stop valve is closed. ② Decrease of power supply voltage ③ Looseness, disconnection or converse of compressor wiring connection ④ Defective compressor ⑤ Defective outdoor power board ⑥ Dip switch setting difference of outdoor controller circuit board. 	<ol style="list-style-type: none"> ① Open stop valve. ② Check facility of power supply. ③ Correct the wiring (U-V-W phase) to compressor. Refer to 10-9 (Outdoor power circuit board). ④ Check compressor. Refer to 10-6. ⑤ Replace outdoor power circuit board. ⑥ Check the dip switch setting of outdoor controller circuit board. Refer to "Model Select" in "1) Function of switches" in 10-10.
UH	Current sensor error or input current error <ul style="list-style-type: none"> • Abnormal if current sensor detects -1.0A to 1.0A during compressor operation. (This error is ignored in case of test run mode.) • Abnormal if 40A of input current is detected or 37A or more of input current is detected for 10 seconds continuously. 	<ol style="list-style-type: none"> ① Disconnection of compressor wiring ② Defective circuit of current sensor on outdoor power circuit board ③ Decrease of power supply voltage 	<ol style="list-style-type: none"> ① Correct the wiring (U-V-W phase) to compressor. Refer to 10-9 (Outdoor power circuit board). ② Replace outdoor power circuit board. ③ Check the facility of power supply.
UP	Compressor overcurrent interruption Abnormal if overcurrent DC bus or compressor is detected after compressor starts operating for 30 seconds.	<ol style="list-style-type: none"> ① Stop valve of outdoor unit is closed. ② Decrease of power supply voltage ③ Looseness, disconnection or converse of compressor wiring connection ④ Defective fan of indoor/outdoor units ⑤ Short cycle of indoor/outdoor units ⑥ Defective input circuit of outdoor controller board ⑦ Defective compressor ⑧ Defective outdoor power circuit board ⑨ Dip switch setting difference of outdoor controller circuit board 	<ol style="list-style-type: none"> ① Open stop valve. ② Check facility of power supply. ③ Correct the wiring (U-V-W phase) to compressor. Refer to 10-9 (Outdoor power circuit board). ④ Check indoor/outdoor fan. ⑤ Solve short cycle. ⑥ Replace outdoor controller circuit board. * Before the replacement of the outdoor controller circuit board, disconnect the wiring to compressor from the outdoor power circuit board and check the output voltage among phases, U, V, W, during test run. No defect on board if voltage among phases (U-V, V-W and W-U) is same. Make sure to perform the voltage check with same performing frequency. ⑦ Check compressor. Refer to 10-6. ⑧ Replace outdoor power circuit board. ⑨ Check the dip switch setting of outdoor controller circuit board.



Error Code	Abnormal points and detection method	Case	Judgment and action
E0 or E4	<p>Remote controller transmission error (E0)/signal receiving error (E4)</p> <p>① Abnormal if main or sub remote controller cannot receive normally any transmission from indoor unit of refrigerant address "0" for 3 minutes. (Error code : E0)</p> <p>② Abnormal if sub remote controller could not receive any signal for 2 minutes. (Error code: E0)</p> <p>① Abnormal if indoor controller board can not receive normally any data from remote controller board or from other indoor controller board for 3 minutes. (Error code: E4)</p> <p>② Indoor controller board cannot receive any signal from remote controller for 2 minutes. (Error code: E4)</p>	<p>① Contact failure at transmission wire of remote controller</p> <p>② All remote controllers are set as "sub" remote controller. In this case, E0 is displayed on remote controller, and E4 is displayed at LED (LED1, LED2) on the outdoor controller circuit board.</p> <p>③ Miswiring of remote controller</p> <p>④ Defective transmitting receiving circuit of remote controller</p> <p>⑤ Defective transmitting receiving circuit of indoor controller board of refrigerant address "0"</p> <p>⑥ Noise has entered into the transmission wire of remote controller.</p>	<p>① Check disconnection or looseness of indoor unit or transmission wire of remote controller.</p> <p>② Set one of the remote controllers "main" if there is no problem with the action above.</p> <p>③ Check wiring of remote controller.</p> <ul style="list-style-type: none"> • Total wiring length: Max. 500m (Do not use cable × 3 or more.) • The number of connecting indoor units: Max. 16 units • The number of connecting remote controller: Max. 2 units <p>When it is not the above-mentioned problem of ①~③</p> <p>④ Diagnose remote controllers.</p> <p>a) When "RC OK" is displayed, Remote controllers have no problem. Turn the power off, and on again to check. If abnormality generates again, replace indoor controller board.</p> <p>b) When "RC NG" is displayed, Replace remote controller.</p> <p>c) When "RCE3" or "ERC00-66" is displayed, noise may be causing abnormality.</p> <p>* If the unit is not normal after replacing indoor controller board in group control, indoor controller board of address "0" may be abnormal.</p>
E1 or E2	<p>Remote controller control board</p> <p>① Abnormal if data cannot be normally read from the nonvolatile memory of the remote controller control board. (Error code: E1)</p> <p>② Abnormal if the clock function of remote controller cannot be normally operated. (Error code: E2)</p>	<p>① Defective remote controller</p>	<p>① Replace remote controller.</p>
E3 or E5	<p>Remote controller transmission error (E3)/signal receiving error (E5)</p> <p>① Abnormal if remote controller could not find blank of transmission path for 6 seconds and could not transmit. (Error code: E3)</p> <p>② Remote controller receives transmitted data at the same time, compares the data, and when detecting it, judges different data to be abnormal 30 continuous times. (Error code: E3)</p> <p>① Abnormal if indoor controller board could not find blank of transmission path. (Error code: E5)</p> <p>② Indoor controller board receives transmitted data at the same time, compares the data, and when detecting it, judges different data to be abnormal 30 continuous times. (Error code: E5)</p>	<p>① 2 remote controller are set as "main." (In case of 2 remote controllers)</p> <p>② Remote controller is connected with 2 indoor units or more.</p> <p>③ Repetition of refrigerant address</p> <p>④ Defective transmitting receiving circuit of remote controller</p> <p>⑤ Defective transmitting receiving circuit of indoor controller board</p> <p>⑥ Noise has entered into transmission wire of remote controller.</p>	<p>① Set a remote controller to main, and the other to sub.</p> <p>② Remote controller is connected with only one indoor unit.</p> <p>③ The address changes to a separate setting.</p> <p>④~⑥ Diagnose remote controller.</p> <p>a) When "RC OK" is displayed, remote controllers have no problem. Turn the power off, and on again to check. When becoming abnormal again, replace indoor controller board.</p> <p>b) When "RC NG" is displayed, replace remote controller.</p> <p>c) When "RC E3" or "ERC 00-66" is displayed, noise may be causing abnormality.</p>







Error Code	Abnormal points and detection method	Case	Judgment and action
E6	Indoor/outdoor unit communication error (Signal receiving error) ① Abnormal if indoor controller board could not receive any signal normally for 6 minutes after turning the power on. ② Abnormal if indoor controller board could not receive any signal normally for 3 minutes. ③ Consider the unit as abnormal under the following condition. When 2 or more indoor units are connected to an outdoor unit, indoor controller board could not receive a signal for 3 minutes from outdoor controller circuit board, a signal which allows outdoor controller circuit board to transmit signals.	① Contact failure, short circuit or miswiring (converse wiring) of indoor/outdoor unit connecting wire ② Defective transmitting receiving circuit of outdoor controller circuit board. ③ Defective transmitting receiving circuit of indoor controller board. ④ Noise has entered into indoor/outdoor unit connecting wire. ⑤ Defective fan motor ⑥ Defective rush current resistor of outdoor power circuit board	* Check LED display on outdoor controller circuit board. (Connect A-Control service tool (PAC-SK52ST)) Refer to EA-EC item if LED displays EA-AC. ① Check disconnecting or looseness of indoor/outdoor unit connecting wire of indoor unit or outdoor unit. Check all the units in case of twin/triple/quadruple indoor unit system. ②-④ Turn the power off, and on again to check. If abnormality generates again, replace indoor controller board or outdoor controller circuit board. * Other indoor controller board may have defect in case of twin/triple/quadruple indoor unit system. ⑤ Turn the power off, and detach fan motor from connector (CNF1, 2). Then turn the power on again. If abnormality is not displayed, replace fan motor. If abnormality is displayed, replace outdoor controller circuit board. ⑥ Check the rush current resistor on outdoor power circuit board with tester. If open is detected, replace the power circuit board.
E8	Indoor/outdoor unit communication error (Signal receiving error) (Outdoor unit) Abnormal if outdoor controller circuit board could not receive anything normally for 3 minutes.	① Contact failure of indoor/outdoor unit connecting wire ② Defective communication circuit of outdoor controller circuit board ③ Defective communication circuit of indoor controller board ④ Noise has entered into indoor/outdoor unit connecting wire.	① Check disconnection or looseness of indoor/outdoor unit connecting wire of indoor or outdoor units. ②-④ Turn the power off, and on again to check. Replace indoor controller board or outdoor controller circuit board if abnormality is displayed again.
E9	Indoor/outdoor unit communication error (Transmitting error) (Outdoor unit) ① Abnormal if "0" receiving is detected 30 times continuously though outdoor controller circuit board has transmitted "1". ② Abnormal if outdoor controller circuit board could not find blank of transmission path for 3 minutes.	① Indoor/ outdoor unit connecting wire has contact failure. ② Defective communication circuit of outdoor controller circuit board ③ Noise has entered power supply. ④ Noise has entered indoor/outdoor unit connecting wire.	① Check disconnection or looseness of indoor/outdoor unit connecting wire. ②-④ Turn the power off, and on again to check. Replace outdoor controller circuit board if abnormality is displayed again.
EF	Non defined error code This code is displayed when non defined error code is received.	① Noise has entered transmission wire of remote controller. ② Noise has entered indoor/outdoor unit connecting wire. ③ Outdoor unit is not a series of power-inverter. ④ Model name of remote controller is PAR-S25A.	①② Turn the power off, and on again to check. Replace indoor controller board or outdoor controller circuit board if abnormality is displayed again. ③ Replace outdoor unit with power-inverter type outdoor unit. ④ Replace remote controller with MA remote controller.
Ed	Serial communication error ① Abnormal if serial communication between outdoor controller circuit board and outdoor power circuit board is defective.	① Breaking of wire or contact failure of connector CN2 between the outdoor controller circuit board and the outdoor power circuit board ② Breaking of wire or contact failure of connector CN4 between the outdoor controller circuit board and the outdoor power circuit board ③ Defective communication circuit of outdoor power circuit board ④ Defective communication circuit of outdoor controller circuit board for outdoor power circuit board	①② Check connection of each connector CN2 and CN4 between the outdoor controller circuit board and the outdoor power circuit board. ③ Replace outdoor power circuit board. ④ Replace outdoor controller circuit board.



Error Code	Abnormal points and detection method	Case	Judgment and action																
P6	<p>Freezing/overheating protection is operating</p> <p>Overheating protection <Heating mode> Abnormal if condensing temperature of pressure sensor (63HS) detects Tcond. °C or more and compressor operation frequency is less than or equal to 25 Hz. Detection is inoperative during defrosting.</p>	<p>① Overcharge of refrigerant ② Defective refrigerant circuit (clogs) ③ Malfunction of linear expansion valve ④ Reduced water flow · Clogged filter · Leakage of water ⑤ High temperature · Over-load · Inlet water is too warm. ⑥ Defective water pump</p>	<p>①② Check operating condition of refrigerant circuit. ③ Check linear expansion valve. ④⑤ Check water piping. ⑥ Check water pump.</p>																
	<table border="1"> <thead> <tr> <th>Tcond</th> <th>stage-a</th> <th>stage-b</th> <th>stage-c</th> <th>stage-d</th> <th>stage-e</th> <th>stage-f</th> <th>stage-g</th> </tr> </thead> <tbody> <tr> <td>SW40/50</td> <td>63</td> <td>61</td> <td>60</td> <td>58</td> <td>56</td> <td>53</td> <td>50</td> </tr> </tbody> </table>	Tcond	stage-a	stage-b	stage-c	stage-d	stage-e	stage-f	stage-g	SW40/50	63	61	60	58	56	53	50		
Tcond	stage-a	stage-b	stage-c	stage-d	stage-e	stage-f	stage-g												
SW40/50	63	61	60	58	56	53	50												
P9	<p>Actual tank temperature thermistor (TH5)</p> <p>① The unit is 3-minute resume prevention mode if short/open of thermistor is detected. Abnormal if the unit does not reset normally after 3 minutes. (The unit returns to normal operation, if it has been reset normally)</p> <p>② Constantly detected during cooling, heating, heating ECO, anti freeze and hot water operation.</p>	<p>① Defective thermistor characteristics ② Contact failure of TB61 No. 5-6 on PCB of interface unit/Flow temp. controller ③ Breaking of wire or contact failure of thermistor wiring ④ Defective PCB of interface unit/Flow temp. controller</p>	<p>①-③ Check resistance value of thermistor. 0°C 15.0kΩ 10°C 9.6kΩ 20°C 6.3kΩ 30°C 4.3kΩ 40°C 3.0kΩ</p> <p>If you put force on (draw or bend) the lead wire with measuring resistance value of thermistor, breaking of wire or contact failure can be detected.</p> <p>② Check contact failure of TB61 No.5-6 on PCB of Interface unit/Flow temp. controller. Refer to 7. WIRING DIAGRAM. Turn the power on again and check restart after inserting connector again.</p> <p>④ Check actual tank temperature display on remote controller. Replace PCB of Interface unit/Flow temp. controller if there is abnormal difference with actual tank temperature. Turn the power off, and on again to operate after check.</p>																

10-4. TROUBLESHOOTING

A flowing water sound or occasional hissing sound is heard.	<ul style="list-style-type: none"> These sounds can be heard when refrigerant and/or water is (are) flowing in the indoor unit or refrigerant pipe, or when the refrigerant and/or water is (are) chugging.
Water does not heat or cool well.	<ul style="list-style-type: none"> Clean the filter of water piping. (Flow is reduced when the filter is dirty or clogged.) Check the temperature adjustment and adjust the set temperature. Make sure that there is plenty of space around the outdoor unit.
Water or vapour is emitted from the outdoor unit.	<ul style="list-style-type: none"> During cooling mode, water may form and drip from the cool pipes and joints. During heating mode, water may form and drip from the heat exchanger of outdoor unit. During defrosting mode, water on the heat exchanger of outdoor unit evaporates and water vapour may be emitted.
The operation indicator does not appear in the remote controller display.	<ul style="list-style-type: none"> Turn on the power switch. "●" will appear in the remote controller display.
"  appears in the remote controller display.	<ul style="list-style-type: none"> During external signal control, "" appears in the remote controller display and FTC operation cannot be started or stopped using the remote controller.
When restarting the outdoor unit soon after stopping it, it does not operate even though the ON/OFF button is pressed.	<ul style="list-style-type: none"> Wait approximately 3 minutes. (Operation has stopped to protect the outdoor unit.)
FTC operates without the ON/OFF button being pressed.	<ul style="list-style-type: none"> Is the on timer set? Press the ON/OFF button to stop operation. Is the FTC connected to a external signal? Consult the concerned people who control the FTC. Does " appear in the remote controller display? Consult the concerned people who control the FTC. Has the auto recovery feature from power failures been set? Press the ON/OFF button to stop operation.
FTC stops without the ON/OFF button being pressed.	<ul style="list-style-type: none"> Is the off timer set? Press the ON/OFF button to restart operation. Is the air conditioner connected to a central remote controller? Consult the concerned people who control the FTC. Does " appear in the remote controller display? Consult the concerned people who control the FTC.
Remote controller timer operation cannot be set.	<ul style="list-style-type: none"> Are timer settings invalid? If the timer can be set, (WEEKLY), (SIMPLE), or (AUTO OFF) appears in the remote controller display.
"PLEASE WAIT" appears in the remote controller display.	<ul style="list-style-type: none"> The initial settings are being performed. Wait approximately 3 minutes. If the remote controller is not only for FTC, change it.
An error code appears in the remote controller display.	<ul style="list-style-type: none"> The protection devices have operated to protect the FTC and outdoor unit. Do not attempt to repair this equipment by yourself. Turn off the power switch immediately and consult your dealer. Be sure to provide the dealer with the model name and information that appeared in the remote controller display.

• If the unit cannot be operated properly after test run, refer to the following table to find the cause.

Symptom		Cause
Wired remote controller	LED 1, 2 (PCB in outdoor unit)	
PLEASE WAIT	For about 2 minutes after power-on After LED 1, 2 are lighted, LED 2 is turned off, then only LED 1 is lighted. (Correct operation)	• For about 2 minutes following power-on, operation of the remote controller is not possible due to system start-up. (Correct operation)
PLEASE WAIT → Error code	Subsequent to about 2 minutes after power-on Only LED 1 is lighted. → LED 1, 2 blink.	• Connector for the outdoor unit's protection device is not connected. • Reverse or open phase wiring for the outdoor unit's power terminal block (L1, L2, L3)
Display messages do not appear even when operation switch is turned ON (operation lamp does not light up).	Only LED 1 is lighted. → LED 1 blinks twice, LED 2 blinks once.	• Incorrect wiring between FTC and outdoor (incorrect polarity of S1, S2, S3) • Remote controller wire short

Note: Operation is not possible for about 30 seconds after cancellation of function selection. (Correct operation)

For description of each LED (LED1, 2, 3) provided on the FTC, refer to the following table.

LED1 (power for microprocessor)	Indicates whether control power is supplied. Make sure that this LED is always lit.
LED2 (power for remote controller)	Indicates whether power is supplied to the remote controller. This LED lights only in the case of the FTC which is connected to the outdoor unit refrigerant addresses "0".
LED3 (communication between FTC and outdoor units)	Indicates state of communication between the FTC and outdoor units. Make sure that this LED is always blinking.

10-5. TROUBLESHOOTING BY INFERIOR PHENOMENA

Phenomena	Factor	Countermeasure
1. Remote controller display does not work.	<p>①DC12V is not supplied to remote controller. (Power supply display ● is not indicated on LCD.)</p> <p>②DC12~15V is supplied to remote controller, however, no display is indicated.</p> <ul style="list-style-type: none"> • "PLEASE WAIT" is not displayed. • "PLEASE WAIT" is displayed. 	<p>①Check LED2 on indoor controller board.</p> <p>(1) When LED2 is lit. Check the remote controller wiring for breaking or contact failure.</p> <p>(2) When LED2 is blinking. Check short circuit of remote controller wiring.</p> <p>(3) When LED2 is not lit. Refer to phenomena No.3 below.</p> <p>②Check the following.</p> <ul style="list-style-type: none"> • Failure of remote controller if "PLEASE WAIT" is not displayed • Refer to phenomena No.2 below if "PLEASE WAIT" is displayed.
2. "PLEASE WAIT" display is remained on the remote controller.	<p>①At longest 2 minutes after the power supply "PLEASE WAIT" is displayed to start up.</p> <p>②Communication error between the remote controller and indoor unit</p> <p>③Communication error between the indoor and outdoor unit</p> <p>④Outdoor unit protection device connector is open.</p>	<p>① Normal operation</p> <p>② Self-diagnosis of remote controller</p> <p>③ "PLEASE WAIT" is displayed for 6 minutes at most in case of indoor/outdoor unit communication error. Check LED3 on indoor controller board.</p> <p>(1) When LED3 is not blinking. Check indoor/outdoor connecting wire for miswiring. (Converse wiring of S1 and S2, or break of S3 wiring.)</p> <p>(2) When LED3 is blinking. Indoor/outdoor connecting wire is normal.</p> <p>④ Check LED display on outdoor controller circuit board. Refer to 10-9. Check protection device connector (63H) for contact failure. Refer to 10-9.</p>
3. When pressing the remote controller operation switch, the OPERATION display is appeared but it will be turned off soon.	<p>①After cancelling to select function from the remote controller, the remote controller operation switch will be not accepted for approx. 30 seconds.</p>	<p>① Normal operation</p>
4. Even controlling by the wireless remote controller, no beep is heard and the unit does not start operating. Operation display is indicated on wireless remote controller.	<p>①The pair number settings of the wireless remote controller and indoor controller board are mismatched.</p>	<p>①Check the pair number settings.</p>
5. When operating by the wireless remote controller, beep sound is heard, however, unit does not start operating.	<p>①No operation for 2 minutes at most after the power supply ON.</p> <p>②Local remote controller operation is prohibited.</p> <ul style="list-style-type: none"> • Remote controlling adaptor is connected to CN32 on the indoor controller board. • Local remote controller operation is prohibited by centralised controller etc. since it is connected to MELANS. <p>③Phenomena of No.2.</p>	<p>①Normal operation</p> <p>②Normal operation</p> <p>③Check the phenomena No.2.</p>
6. Remote controller display works normally and the unit performs cooling operation, however, the capacity cannot be fully obtained. (The air does not cool well.)	<p>①Refrigerant shortage</p> <p>②Filter clogging</p> <p>③Heat exchanger clogging</p> <p>④Air duct short cycle</p>	<p>①• If refrigerant leaks, discharging temperature rises and LEV opening increases. Inspect leakage by checking the temperature and opening.</p> <ul style="list-style-type: none"> • Check pipe connections for gas leakage. <p>②Open intake grille and check the filter. Clean the filter by removing dirt or dust on it.</p> <p>③• If the filter is clogged, indoor pipe temperature rises and discharging pressure increases. Check if heat exchanger is clogged by inspecting discharging pressure.</p> <ul style="list-style-type: none"> • Clean the heat exchanger. <p>④Remove the blockage.</p>



Phenomena	Factor	Countermeasure
<p>7. Remote controller display works normally and the unit performs heating operation, however, the capacity cannot be fully obtained.</p>	<p>① Linear expansion valve fault Opening cannot be adjusted well due to linear expansion valve fault.</p> <p>② Refrigerant shortage</p> <p>③ Lack of insulation for refrigerant piping</p> <p>④ Filter clogging</p> <p>⑤ Heat exchanger clogging</p> <p>⑥ Air duct short cycle</p> <p>⑦ Bypass circuit of outdoor unit fault</p>	<p>① • Discharging temperature and indoor heat exchanger temperature does not rise. Inspect the failure by checking discharging pressure.</p> <ul style="list-style-type: none"> • Replace linear expansion valve. <p>② • If refrigerant leaks, discharging temperature rises and LEV opening increases. Inspect leakage by checking the temperature and opening.</p> <ul style="list-style-type: none"> • Check pipe connections for gas leakage. <p>③ Check the insulation.</p> <p>④ Open intake grille and check the filter. Clean the filter by removing dirt or dust on it.</p> <p>⑤ • If the filter is clogged, indoor pipe temperature rises and discharging pressure increases. Check if heat exchanger is clogged by inspecting discharging pressure.</p> <ul style="list-style-type: none"> • Clean the heat exchanger. <p>⑥ Remove the blockage.</p> <p>⑦ Check refrigerant system during operation.</p>
<p>8. ① For 3 minutes after temperature adjuster turns off, the compressor will not start operating even if temperature adjuster is turned on.</p> <p>② For 3 minutes after temperature adjuster turns on, the compressor will not stop operating even if temperature adjuster is turned off. (Compressor stops operating immediately when turning off by the remote controller.)</p>	<p>①② Normal operation (For protection of compressor)</p>	<p>①② Normal operation</p>

Symptoms: "PLEASE WAIT" is kept being displayed on the remote controller.

Diagnosis flow	Cause	Inspection method and troubleshooting
<pre> graph TD Start[Check the display time of "PLEASE WAIT" after turning on the main power.] --> D1{How long is "PLEASE WAIT" kept being displayed on the remote controller?} D1 -- "2 minutes or less" --> C1[• "PLEASE WAIT" will be displayed during the start-up diagnosis after turning on the main power.] D1 -- "2 to 6 minutes" --> D2{Are any error codes displayed on the remote controller?} D1 -- "6 minutes or more" --> C2[• Defective indoor controller board • Defective remote controller] D2 -- NO --> C1 D2 -- YES --> C3[Check the LED display of the outdoor controller circuit board.] C3 --> D3{Are any error codes displayed on the LED?} D3 -- YES --> C4[• Miswiring of indoor/outdoor connecting wire • Breaking of indoor/outdoor connecting wire (S3) • Defective indoor controller board • Defective outdoor controller circuit board] D3 -- NO --> C2 </pre>	<ul style="list-style-type: none"> • "PLEASE WAIT" will be displayed during the start-up diagnosis after turning on the main power. • Miswiring of indoor/outdoor connecting wire • Breaking of indoor/outdoor connecting wire (S3) • Defective indoor controller board • Defective outdoor controller circuit board • Defective indoor controller board • Defective remote controller 	<ul style="list-style-type: none"> • Normal. The start-up diagnosis will be over in around 2 minutes. • Refer to "Self-diagnosis action table" in order to solve the trouble. • In case of communication errors, the display of remote controller may not match the LED display of the outdoor unit.

Symptoms: Nothing is displayed on the remote controller ①

LED display of the indoor controller board
 LED1 : ○
 LED2 : ○
 LED3 : ○



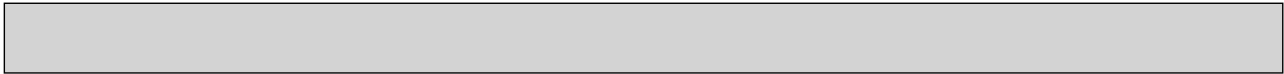

Diagnosis flow	Cause	Inspection method and troubleshooting
<p>Check the voltage between S1 and S2 on the terminal block (TB4) of the indoor unit which is used to connect the indoor unit and the outdoor unit.</p> <p>AC 198V to AC 264V?</p> <p>NO → Check the voltage among L(L_s) and N on the terminal block (TB1) of the outdoor power circuit board.</p> <p>AC 198V to AC 264V?</p> <p>NO →</p> <p>YES → Check the voltage between S1 and S2 on the terminal block (TB1) of the outdoor unit which is used to connect the indoor unit and the outdoor unit.</p> <p>AC 198V to AC 264V?</p> <p>NO →</p> <p>YES → Check the voltage of indoor controller board (CN2D).</p> <p>DC 12V to DC 16V?</p> <p>YES →</p> <p>NO → Check the voltage of the unit after removing the indoor power board (CN2S).</p> <p>DC 12V to DC 16V?</p> <p>YES →</p> <p>NO →</p>	<p>• Troubles concerning power supply.</p> <p>• Bad wiring of the outdoor controller board.</p> <p>• The fuses on the outdoor controller circuit board are blown.</p> <p>• Bad wiring of the outdoor controller board.</p> <p>• The fuses on the outdoor controller circuit board are blown.</p> <p>• Defective indoor controller board</p> <p>• Miswiring, breaking or poor connection of indoor/outdoor connecting wire</p> <p>• Defective indoor power board</p>	<p>• Check the power wiring to the outdoor unit.</p> <p>• Check the breaker.</p> <p>• Check the wiring of the outdoor unit.</p> <p>• Check if the wiring is bad. Check if the fuses are blown. The fuses on the outdoor controller circuit board will be blown when the indoor /outdoor connecting wire short-circuits.</p> <p>• Check if miswiring, breaking or poor contact is causing this problem. Indoor/outdoor connecting wire is polarized 3-core type. Connect the indoor unit and the outdoor unit by wiring each pair of S1, S2 and S3 on the both side of indoor/outdoor terminal blocks.</p> <p>• Replace the indoor controller board.</p> <p>• Check if there is miswiring or breaking of wire.</p> <p>• Replace the indoor power board.</p>



Symptoms: Nothing is displayed on the remote controller ②	LED display of the indoor controller board LED1 : LED2 : LED3 : or
--	--

Diagnosis flow	Cause	Inspection method and troubleshooting
<p>Check the voltage between S1 and S2 on the terminal block (TB4) of the indoor unit which is used to connect the indoor unit and the outdoor unit.</p> <p>AC 198V to AC 264V?</p> <p>NO → Check the looseness or disconnection of the indoor/outdoor connecting wire.</p> <p>YES → Check the status of the indoor controller board LED3 display.</p> <p>Not lighting. → Check the looseness or disconnection of the indoor/outdoor connecting wire.</p> <p>Blinking. → Are there looseness or disconnection of the indoor/outdoor connecting wire?</p> <p>Are there looseness or disconnection of the indoor/outdoor connecting wire?</p> <p>YES → Breaking or poor contact of the indoor/outdoor connecting wire</p> <p>NO → Check the refrigerant address of the outdoor unit. (SW1-3 to 1-6)</p> <p>Is the refrigerant address "0"?</p> <p>NO → Normal. Only the unit which has the refrigerant address "0" supplies power to the remote controller.</p> <p>YES → Check the LED display of the outdoor unit after turning on the main power again.</p> <p>Is anything displayed?</p> <p>Not displayed. → Defective outdoor controller circuit board</p> <p>Displayed. → Is "EA" or "Eb" displayed?</p> <p>NO → Is "E8" displayed?</p> <p>YES → Defective outdoor controller circuit board</p> <p>NO → Can the unit be restarted?</p> <p>Can the unit be restarted? → Can all the indoor unit be operated?</p> <p>NO → Defective indoor controller board</p> <p>YES → Influence of electromagnetic noise</p> <p>Check the voltage between S2 and S3 on the terminal block of the outdoor unit.</p> <p>DC 17V to DC 28V?</p> <p>NO → Defective outdoor power circuit board</p> <p>YES → Defective indoor power board</p>	<ul style="list-style-type: none"> • Breaking or poor contact of the indoor/outdoor connecting wire • Normal. Only the unit which has the refrigerant address "0" supplies power to the remote controller. • Defective outdoor controller circuit board • Defective outdoor controller circuit board • Defective indoor controller board • Influence of electromagnetic noise • Defective outdoor power circuit board • Defective indoor power board 	<ul style="list-style-type: none"> • Fix the breaking or poor contact of the indoor/outdoor connecting wire. • Set the refrigerant address to "0". In case of the multiple grouping system, recheck the refrigerant address again. • Replace the outdoor controller circuit board. • Replace the outdoor controller circuit board. • Replace the indoor controller board of the indoor unit which doesn't operate. • Not abnormal. There may be the influence of electromagnetic noise. Check the transmission wire and get rid of the causes. • Replace the outdoor power circuit board. • Replace the indoor power board.

Symptoms: Nothing is displayed on the remote controller ③

LED display of the indoor controller board
 LED1 : 
 LED2 :  or 
 LED3 : 

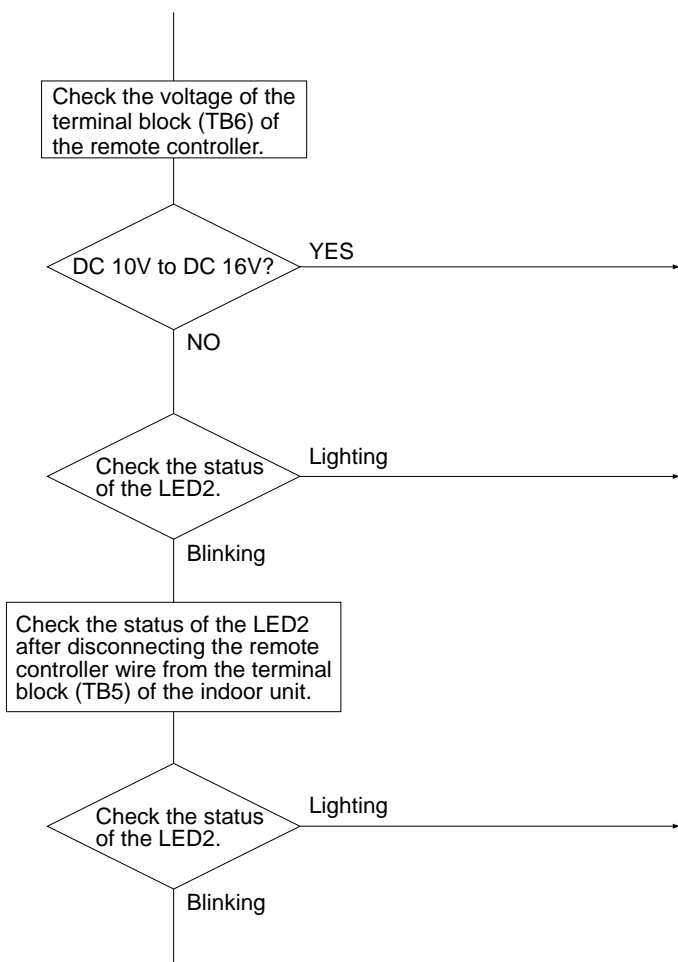
Diagnosis flow	Cause	Inspection method and troubleshooting
 <pre> graph TD Start(()) --> Step1[Check the voltage of the terminal block (TB6) of the remote controller.] Step1 --> Dec1{DC 10V to DC 16V?} Dec1 -- YES --> Cause1[Defective remote controller] Dec1 -- NO --> Step2[Check the status of the LED2.] Step2 -- Lighting --> Cause2[Breaking or poor contact of the remote controller wire] Step2 -- Blinking --> Step3[Check the status of the LED2 after disconnecting the remote controller wire from the terminal block (TB5) of the indoor unit.] Step3 -- Lighting --> Cause3[The remote controller wire short-circuits] Step3 -- Blinking --> Cause4[Defective indoor controller board] </pre>	<ul style="list-style-type: none"> • Defective remote controller • Breaking or poor contact of the remote controller wire • The remote controller wire short-circuits • Defective indoor controller board 	<ul style="list-style-type: none"> • Replace the remote controller. • Check if there is breaking or poor contact of the remote controller wire. Check the voltage of the terminal block (TB5) connecting the remote controller wire. If it is not between DC 10V and DC16V, the indoor controller board must be defective. • Check if the remote controller wire is short-circuited. • Replace the indoor controller board.

• **Before repair**
Frequent calling from customers

Phone Calls From Customers		How to Respond	Note
Unit does not operate at all.	① The operating display of remote controller does not come on.	① Check if power is supplied to air conditioner. Nothing appears on the display unless power is supplied.	_____
	② Unit cannot be restarted for a while after it's stopped.	② Wait around 3 minutes to restart unit. The air conditioner is in a state of being protected by the microcomputer's directive. Once the compressor is stopped, the unit cannot be restarted for 3 minutes. This control is also applied when the unit is turned on and off by remote controller.	_____
	③ Error code appears and blinks on the display of remote controller.	③ Error code will be displayed if any protection devices of the air conditioner are actuated. What is error code? -----	Refer to "SELF-DIAGNOSIS ACTION TABLE". ▶Check if servicing is required for the error.
Remote controller	① "PLEASE WAIT" is displayed on the screen.	① Wait around 2 minutes. An automatic startup test will be conducted for 2 minutes when power is supplied to the air conditioner. "PLEASE WAIT" will be kept being displayed while that time.	_____
	② "FILTER" is displayed on the screen.	② This indicates that it is time to clean the air filters. Clean the air filters. Press the FILTER button on the remote controller twice to clear "FILTER" from the display. See the operation manual that came with the product for how to clean the filters.	Display time of "FILTER" depends on the model. Long life filter: 2500 hrs. Standard filter: 100 hrs.
	③ "STANDBY" is displayed on the screen.	③ This is displayed when the unit starts HEAT operation, when the thermostat puts the compressor in operation mode, or when the outdoor unit ends DEFROST operation and returns to HEAT operation. The display will automatically disappear around 10 minutes later. While "STANDBY" is displayed on the remote controller, the airflow amount will be restricted because the indoor unit's heat exchanger is not fully heated up. In addition to that, the up/down vane will be automatically set to horizontal blow in order to prevent cold air from directly blowing out to human body. The up/down vane will return to the setting specified by the remote controller when "STANDBY" is released.	_____
	④ "DEFROST" is displayed on the screen. (No air comes out of the unit.)	④ The outdoor unit gets frosted when the outside temperature is low and the humidity is high. "DEFROST" indicates the DEFROST operation is being performed to melt this frost. The DEFROST operation ends in around 10 minutes (at most 15 minutes). During the DEFROST operation, the indoor unit's heat exchanger becomes cold, so the fan is stopped. The up/down vane will be automatically set to horizontal blow in order to prevent cold air from directly blowing out to human body. The display will turn into "STANDBY" when DEFROST operation ends.	_____



Phone Calls From Customers	How to Respond	Note	
The room cannot be cooled or heated sufficiently.	① Check the set temperature of remote controller. The outdoor unit cannot be operated if the set temperature is not appropriate. The outdoor unit operates in the following modes. COOL: When the set temperature is lower than the room temperature. HEAT: When the set temperature is higher than the room temperature.	_____	
	② Check if filters are not dirty and clogged. If filters are clogged, the airflow amount will be reduced and the unit capacity will be lowered. See the instruction manual that came with the product for how to clean the filters.	_____	
	③ Check there is enough space around the air conditioner. If there are any obstacles in the air intake or air outlet of indoor/outdoor units, they block the airflow direction so that the unit capacity will be lowered.	_____	
Sound comes out from the air conditioner.	① A gas escaping sound is heard sometimes.	① This is not a malfunction. This is the sound which is heard when the flow of refrigerant in the air conditioner is switched.	_____
	② A cracking sound is heard sometimes.	② This is not a malfunction. This is the sound which is heard when internal parts of units expand or contract when the temperature changes.	_____
	③ A buzzing sound is heard sometimes.	③ This is not a malfunction. This is the sound which is heard when the outdoor unit starts operating.	_____
	④ A ticking sound is heard from the outdoor unit sometimes.	④ This is not a malfunction. This is the sound which is heard when the fan of the outdoor unit is controlling the airflow amount in order to keep the optimum operating condition.	_____
	⑤ A sound, similar to water flowing, is heard from the unit.	⑤ This is not a malfunction. This is the sound which is heard when the refrigerant is flowing inside the indoor unit.	_____
Something is wrong with the blower.....	① The fan speed does not match the setting of the remote controller during DRY operation. (No air comes out sometimes during DRY operation.)	① This is not a malfunction. During the DRY operation, the blower's ON/OFF is controlled by the microcomputer to prevent overcooling and to ensure efficient dehumidification. The fan speed cannot be set by the remote controller during DRY operation.	_____
	② The fan speed does not match the setting of the remote controller in HEAT operation.	② This is not a malfunction. 1) When the HEAT operation starts, to prevent the unit from blowing cold air, the fan speed is gradually increased from zero to the set speed, in proportion to the temperature rise of the discharged air. 2) When the room temperature reaches the set temperature and the outdoor unit stops, the unit starts the LOW AIR operation. 3) During the HEAT operation, the DEFROST operation is performed to defrost the outdoor unit. During the DEFROST operation, the blower is stopped to prevent cold air coming out of the indoor unit.	The up/down vane will be automatically set to horizontal blow in these cases listed up on the left (①~③). After a while, the up/down vane will be automatically moved according to the setting of the remote controller.



Phone Calls From Customers	How to Respond	Note
Something is wrong with the blower.....	③ This is not a malfunction. The blower is operating just for cooling down the heated-up air conditioner. This will be done within 1 minute. This control is conducted only when the HEAT operation is stopped with the electric heater ON.	However, this control is also applied to the models which has no electric heater.
Something is wrong with the airflow direction....	① If the up/down vane is set to downward in COOL operation, it will be automatically set to horizontal blow by the microcomputer in order to prevent water from dropping down. "1 Hr." will be displayed on the remote controller if the up/down vane is set to downward with the fan speed set to be less than "LOW".	_____
	② In HEAT operation, the up/down vane is automatically controlled according to the temperature of the indoor unit's heat exchanger. In the following cases written below, the up/down vane will be set to horizontal blow, and the setting cannot be changed by remote controller. 1) At the beginning of the HEAT operation 2) While the outdoor unit is being stopped by thermostat or when the outdoor unit gets started to operate. 3) During DEFROST operation The airflow direction will be back to the setting of remote controller when the above situations are released.	"STANDBY" will be displayed on the remote controller in case of ① and ②. "DEFROSTING" will be displayed on the screen in case of ③.
	③ 1) Check if the vane is set to a fixed position. (Check if the vane motor connector is removed.) 2) Check if the air conditioner has a function for switching the air direction. 3) If the air conditioner doesn't have that function, "NOT AVAILABLE" will be displayed on the remote controller when "AIR DIRECTION" or "LOUVER" button is pressed.	_____
The air conditioner starts operating even though any buttons on the remote controller are not pressed.	① Check if you set ON/OFF timer. The air conditioner starts operating at the time designated if ON timer has been set before.	_____
	② Check if any operations are ordered by distant control system or the central remote controller. While "CENTRALLY CONTROLLED INDICATOR" is displayed on the remote controller, the air conditioner is under the control of external directive.	There might be a case that "CENTRALLY CONTROLLED INDICATOR" will not be displayed.
	③ Check if power is recovered from power failure (black out). The units will automatically start operating when power is recovered after power failure (black out) occurs. This function is called "auto recovery feature from power".	_____
The air conditioner stops even though any buttons on the remote controller are not pressed.	① Check if you set ON/OFF timer. The air conditioner stops operating at the time designated if OFF timer has been set before. ② Check if any operations are ordered by distant control system or the central remote controller. While "CENTRALLY CONTROLLED INDICATOR" is displayed on the remote controller, the air conditioner is under the control of external directive.	There might be a case that "CENTRALLY CONTROLLED INDICATOR" will not be displayed.



Phone Calls From Customers	How to Respond	Note
A white mist is expelled from the indoor unit.	This is not a malfunction. This may occur when the operation gets started in the room of high humidity.	—
Water or moisture is expelled from the outdoor unit.	Cooling; when pipes or piping joints are cooled, they get sweated and water drips down. Heating; water drips down from the heat exchanger. * Make use of optional parts "Drain Socket" and "Drain pan" if these water needs to be collected and drained out for once.	—
The display of wireless remote controller gets dim or does not come on. The indoor unit does not receive a signal from remote controller at a long distance.	Batteries are being exhausted. Replace them and press the reset button of remote controller.	—

10-6. HOW TO CHECK THE PARTS

PUHZ-SW40VHA

PUHZ-SW40VHA-BS

PUHZ-SW50VHA

PUHZ-SW50VHA-BS

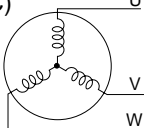
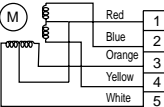
Parts name	Check points														
Thermistor (TH3) <Liquid> Thermistor (TH4) <Discharge> Thermistor (TH6) <2-phase pipe> Thermistor (TH7) <Ambient> Thermistor (TH8) <Heatsink> Thermistor (TH34) <Comp. Surface>	Disconnect the connector then measure the resistance with a tester. (At the ambient temperature 10°C ~30°C) <table border="1" style="margin-left: 20px;"> <thead> <tr> <th></th> <th>Normal</th> <th>Abnormal</th> </tr> </thead> <tbody> <tr> <td>TH4 TH34</td> <td>160kΩ~410kΩ</td> <td rowspan="3">Open or short</td> </tr> <tr> <td>TH3 TH6 TH7</td> <td>4.3kΩ~9.6kΩ</td> </tr> <tr> <td>TH8</td> <td>39kΩ~105kΩ</td> </tr> </tbody> </table>		Normal	Abnormal	TH4 TH34	160kΩ~410kΩ	Open or short	TH3 TH6 TH7	4.3kΩ~9.6kΩ	TH8	39kΩ~105kΩ				
	Normal	Abnormal													
TH4 TH34	160kΩ~410kΩ	Open or short													
TH3 TH6 TH7	4.3kΩ~9.6kΩ														
TH8	39kΩ~105kΩ														
Fan motor(MF1)	Refer to next page.														
Solenoid valve coil <Four-way valve> (21S4)	Measure the resistance between the terminals with a tester. (At the ambient temperature 20°C) <table border="1" style="margin-left: 20px;"> <thead> <tr> <th>Normal</th> <th>Abnormal</th> </tr> </thead> <tbody> <tr> <td>2350±170Ω</td> <td>Open or short</td> </tr> </tbody> </table>	Normal	Abnormal	2350±170Ω	Open or short										
Normal	Abnormal														
2350±170Ω	Open or short														
Motor for compressor (MC) 	Measure the resistance between the terminals with a tester. (Winding temperature 20°C) <table border="1" style="margin-left: 20px;"> <thead> <tr> <th>Normal</th> <th>Abnormal</th> </tr> </thead> <tbody> <tr> <td>0.64Ω</td> <td>Open or short</td> </tr> </tbody> </table>	Normal	Abnormal	0.64Ω	Open or short										
Normal	Abnormal														
0.64Ω	Open or short														
Linear expansion valve (LEV-A/ LEV-B) For SW40-50 	Disconnect the connector then measure the resistance with a tester. (Winding temperature 20°C) <table border="1" style="margin-left: 20px;"> <thead> <tr> <th colspan="4">Normal</th> <th>Abnormal</th> </tr> </thead> <tbody> <tr> <td>Red - White</td> <td>Red - Orange</td> <td>Red - Yellow</td> <td>Red - Blue</td> <td rowspan="2">Open or short</td> </tr> <tr> <td colspan="4">46±4Ω</td> </tr> </tbody> </table>	Normal				Abnormal	Red - White	Red - Orange	Red - Yellow	Red - Blue	Open or short	46±4Ω			
Normal				Abnormal											
Red - White	Red - Orange	Red - Yellow	Red - Blue	Open or short											
46±4Ω															

Check method of DC fan motor (fan motor / outdoor controller circuit board)

① Notes

- High voltage is applied to the connector (CNF1, 2) for the fan motor. Pay attention to the service.
- Do not pull out the connector (CNF1, 2) for the motor with the power supply on.
(It causes trouble of the outdoor controller circuit board and fan motor.)

② Self check

Symptom : The outdoor fan cannot turn around.

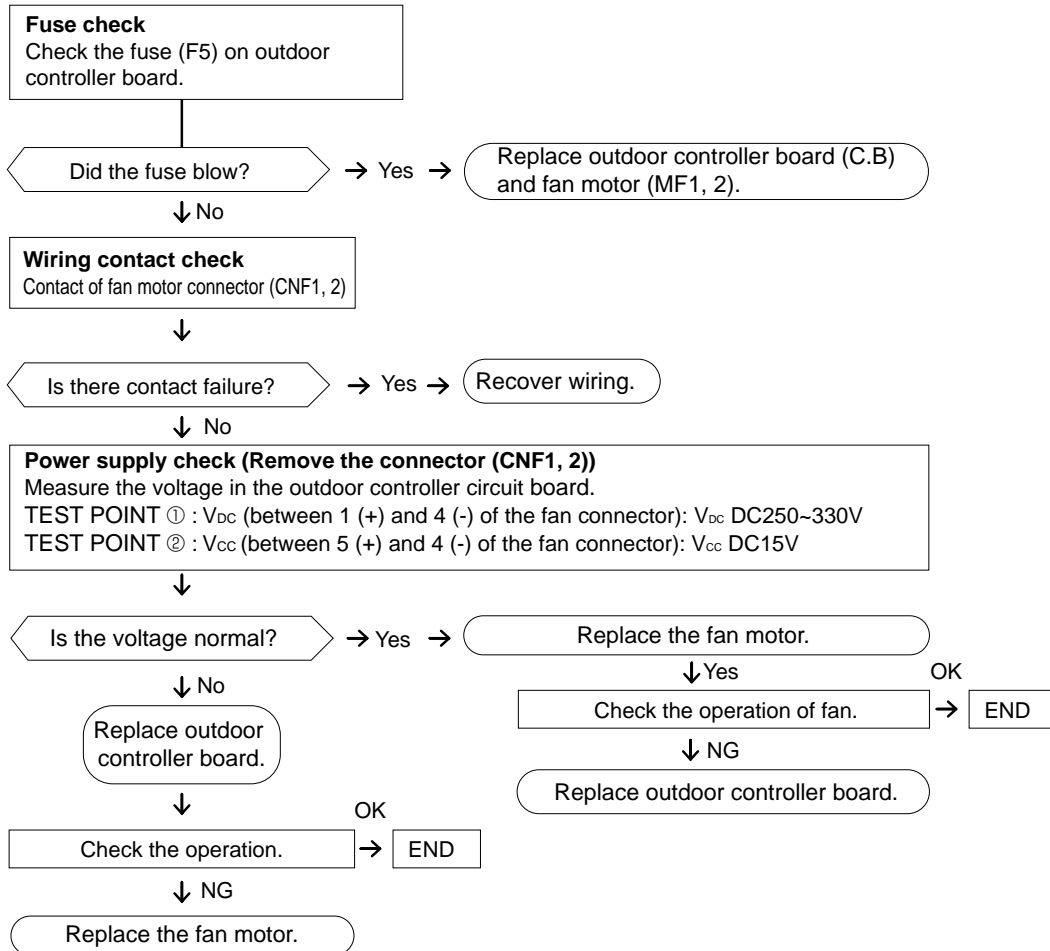

10-7. HOW TO CHECK THE COMPONENTS

<HIGH PRESSURE SENSOR>

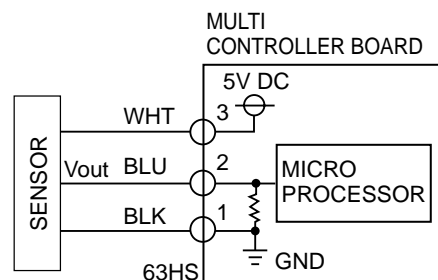
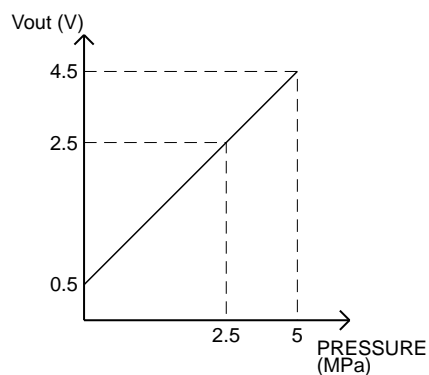

- ③-① : 5V (DC)
- ②-① : Output Vout (DC)

10-8. HOW TO CHECK THE COMPONENTS

<Thermistor feature chart>

Low temperature thermistors

- Thermistor <Liquid> (TH3)
- Thermistor <2-phase pipe> (TH6)
- Thermistor <Ambient> (TH7)

Thermistor R0 = 15kΩ ± 3%

B constant = 3480 ± 2%

$$R_t = 15 \exp\left\{3480 \left(\frac{1}{273+t} - \frac{1}{273} \right)\right\}$$

0°C	15kΩ	30°C	4.3kΩ
10°C	9.6kΩ	40°C	3.0kΩ
20°C	6.3kΩ		
25°C	5.2kΩ		

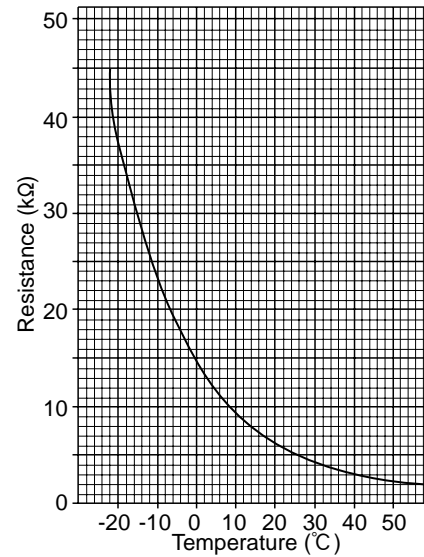

Medium temperature thermistor

- Thermistor <Heatsink> (TH8)

Thermistor R50 = 17kΩ ± 2%

B constant = 4150 ± 3%

$$R_t = 17 \exp\left\{4150 \left(\frac{1}{273+t} - \frac{1}{323} \right)\right\}$$

0°C	180kΩ
25°C	50kΩ
50°C	17kΩ
70°C	8kΩ
90°C	4kΩ

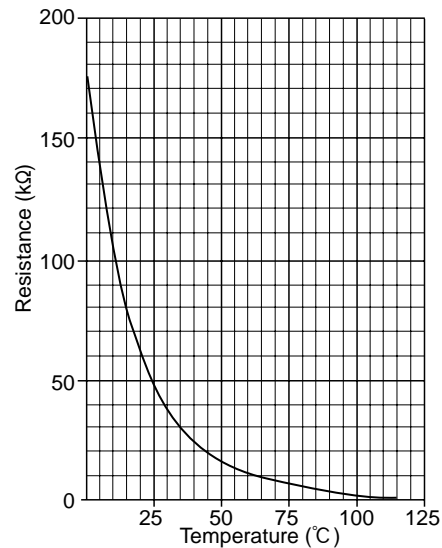

High temperature thermistor

- Thermistor <Discharge> (TH4)
- Thermistor <Comp.surface> (TH34)

Thermistor R120 = 7.465kΩ ± 2%

B constant = 4057 ± 2%

$$R_t = 7.465 \exp\left\{4057 \left(\frac{1}{273+t} - \frac{1}{393} \right)\right\}$$

20°C	250kΩ	70°C	34kΩ
30°C	160kΩ	80°C	24kΩ
40°C	104kΩ	90°C	17.5kΩ
50°C	70kΩ	100°C	13.0kΩ
60°C	48kΩ	110°C	9.8kΩ

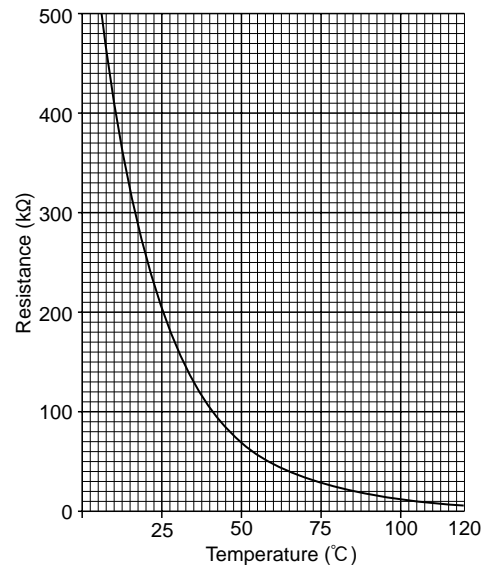

Linear expansion valve

(1) Operation summary of the linear expansion valve

- Linear expansion valve opens/closes through stepping motor after receiving the pulse signal from the outdoor controller board.
 - Valve position can be changed in proportion to the number of pulse signal.
- <Connection between the outdoor controller board and the linear expansion valve>

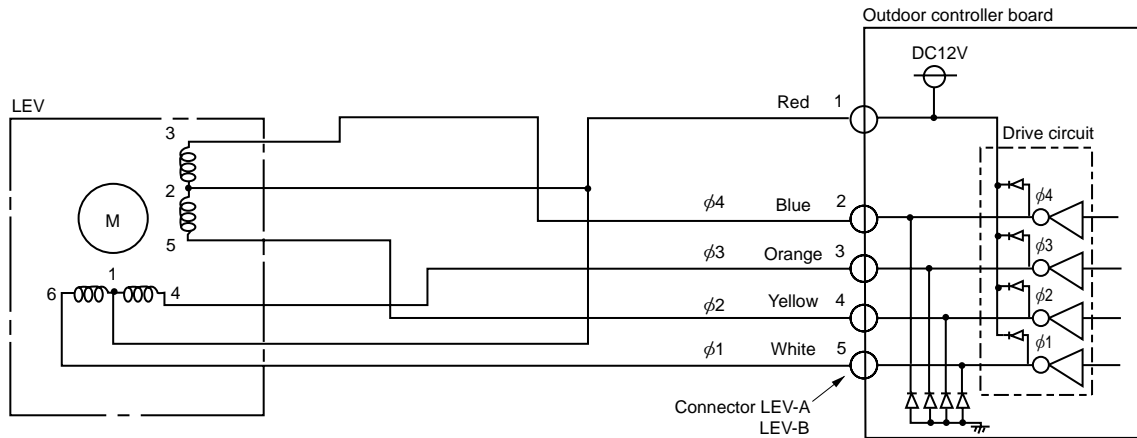

<Output pulse signal and the valve operation>

Output (Phase)	Output							
	1	2	3	4	5	6	7	8
$\phi 1$	ON	ON	OFF	OFF	OFF	OFF	OFF	ON
$\phi 2$	OFF	ON	ON	ON	OFF	OFF	OFF	OFF
$\phi 3$	OFF	OFF	OFF	ON	ON	ON	OFF	OFF
$\phi 4$	OFF	OFF	OFF	OFF	OFF	ON	ON	ON

Opening a valve : 8 → 7 → 6 → 5 → 4 → 3 → 2 → 1 → 8

Closing a valve : 1 → 2 → 3 → 4 → 5 → 6 → 7 → 8 → 1

The output pulse shifts in above order.

- When linear expansion valve operation stops, all output phase become OFF.

(2) Linear expansion valve operation

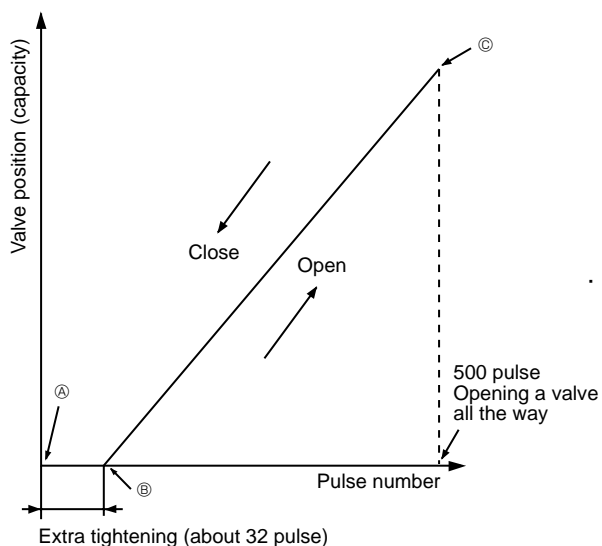

- When the switch is turned on, 700 pulse closing valve signal will be sent till it goes to ③ point in order to define the valve position. (The pulse signal is being sent for about 20 seconds.)

When the valve moves smoothly, there is no sound or vibration occurring from the linear expansion valve : however, when the pulse number moves from ③ to ④ or when the valve is locked, more sound can be heard.

No sound is heard when the pulse number moves from ③ to ④ in case coil is burnt out or motor is locked by open-phase.

- Sound can be detected by placing the ear against the screw driver handle while putting the screw driver to the linear expansion valve.

(3) How to attach and detach the coil of linear expansion valve

<Composition>

Linear expansion valve is separable into the main body and the coil as shown in the diagram below.

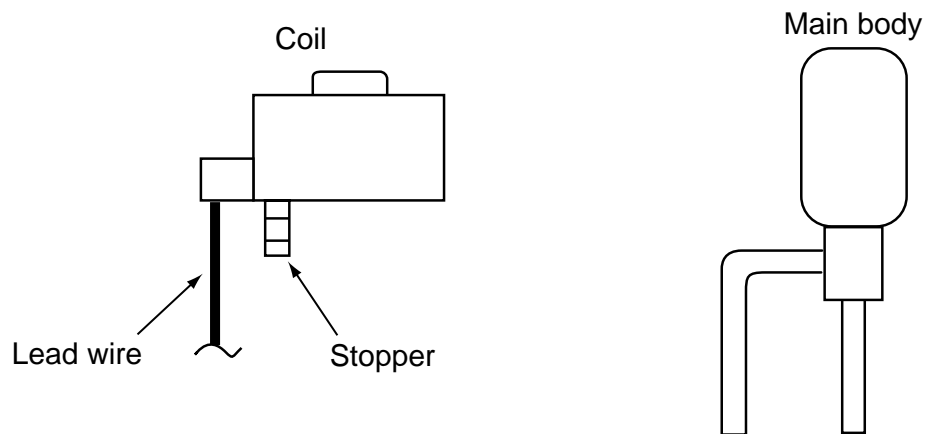

<How to detach the coil>

Hold the lower part of the main body (shown as A) firmly so that the main body does not move and detach the coil by pulling it upward.

Be sure to detach the coil holding main body firmly. Otherwise pipes can bend due to pressure.

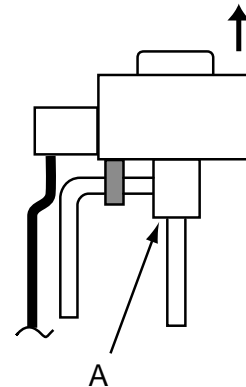

<How to attach the coil>

Hold the lower part of the main body (shown as A) firmly so that the main body does not move and attach the coil by inserting it downward into the main body. Then securely attach the coil stopper to pipe B. (At this time, be careful that stress is not added to lead wire and main body is not wound by lead wire.) If the stopper is not firmly attached to pipe B, coil may be detached from the main body and that can cause defective operation of linear expansion valve.

To prevent piping stress, be sure to attach the coil holding the main body of linear expansion valve firmly. Otherwise pipe may break.

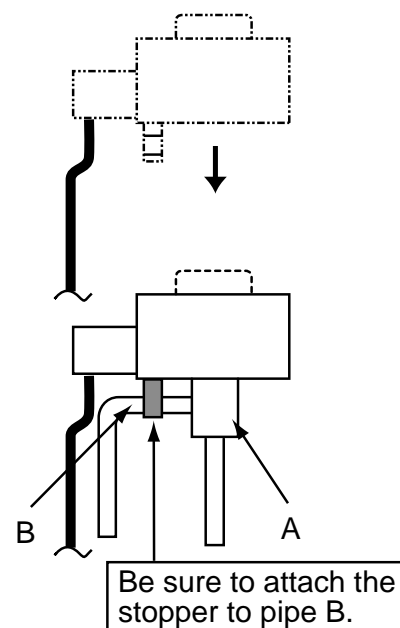

10-9. TEST POINT DIAGRAM

Outdoor controller circuit board

PUHZ-SW40VHA PUAZ-SW40VHA-BS

PUHZ-SW50VHA PUAZ-SW50VHA-BS

<CAUTION> TEST POINT① is high voltage.

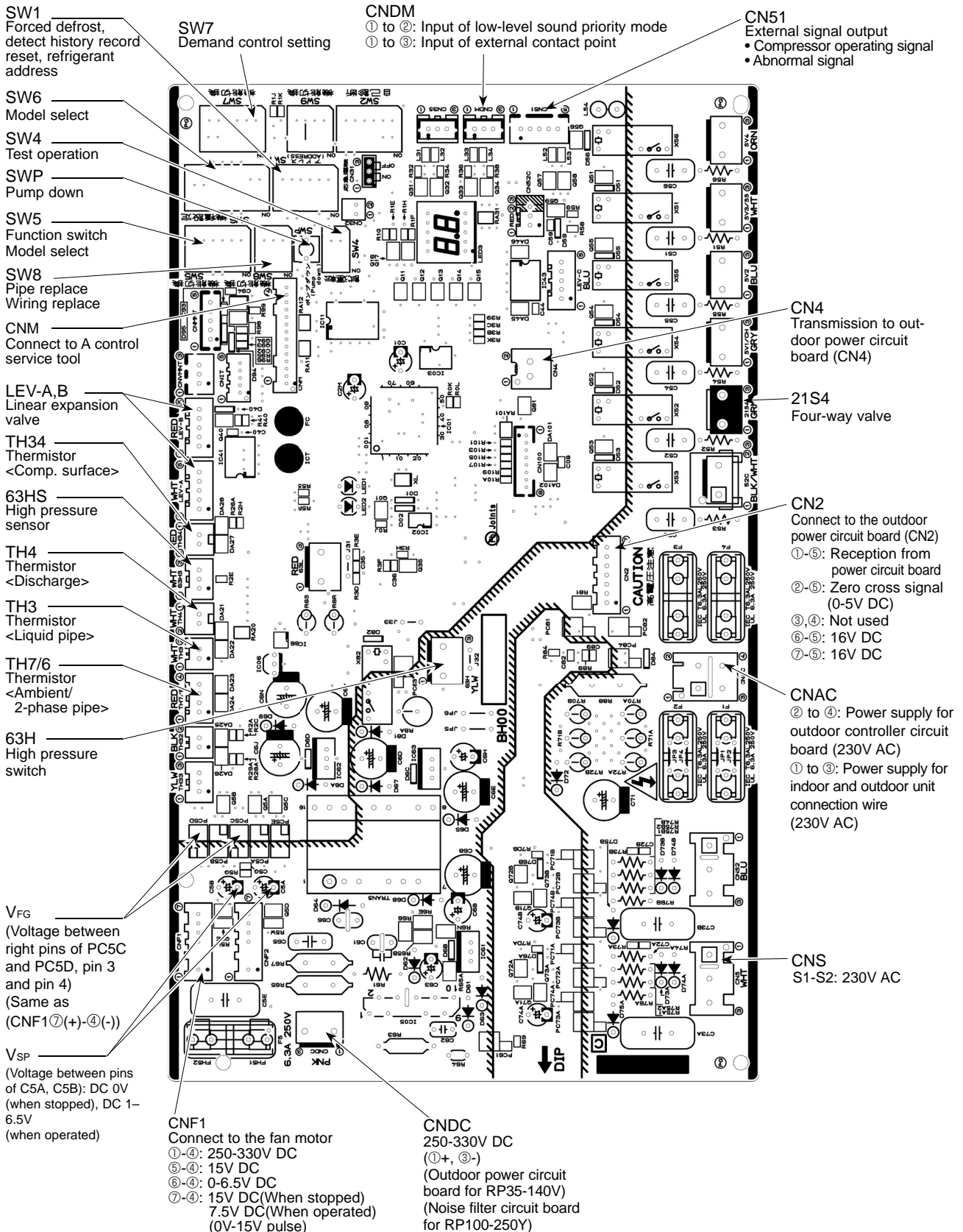

Outdoor noise filter circuit board
PUHZ-SW40VHA
PUHZ-SW40VHA-BS
PUHZ-SW50VHA
PUHZ-SW50VHA-BS

LI, NI
 Voltage of 230V AC is input.
 (Connect to the terminal block (TB1))

E1
 Connect to the earth

E2
 Connect to the earth

E3
 Connect to the earth

CNAC1, CNAC2
 230V AC
 (Connect to the outdoor controller circuit board (CNAC))

CN5
 Primary current
 (Connect to the outdoor power circuit board (CN5))

LO, NO
 Voltage of 230V AC is output.
 (Connect to the ACL)

CN52C
 52C relay signal
 (Connect to the outdoor controller circuit board (CN52C))

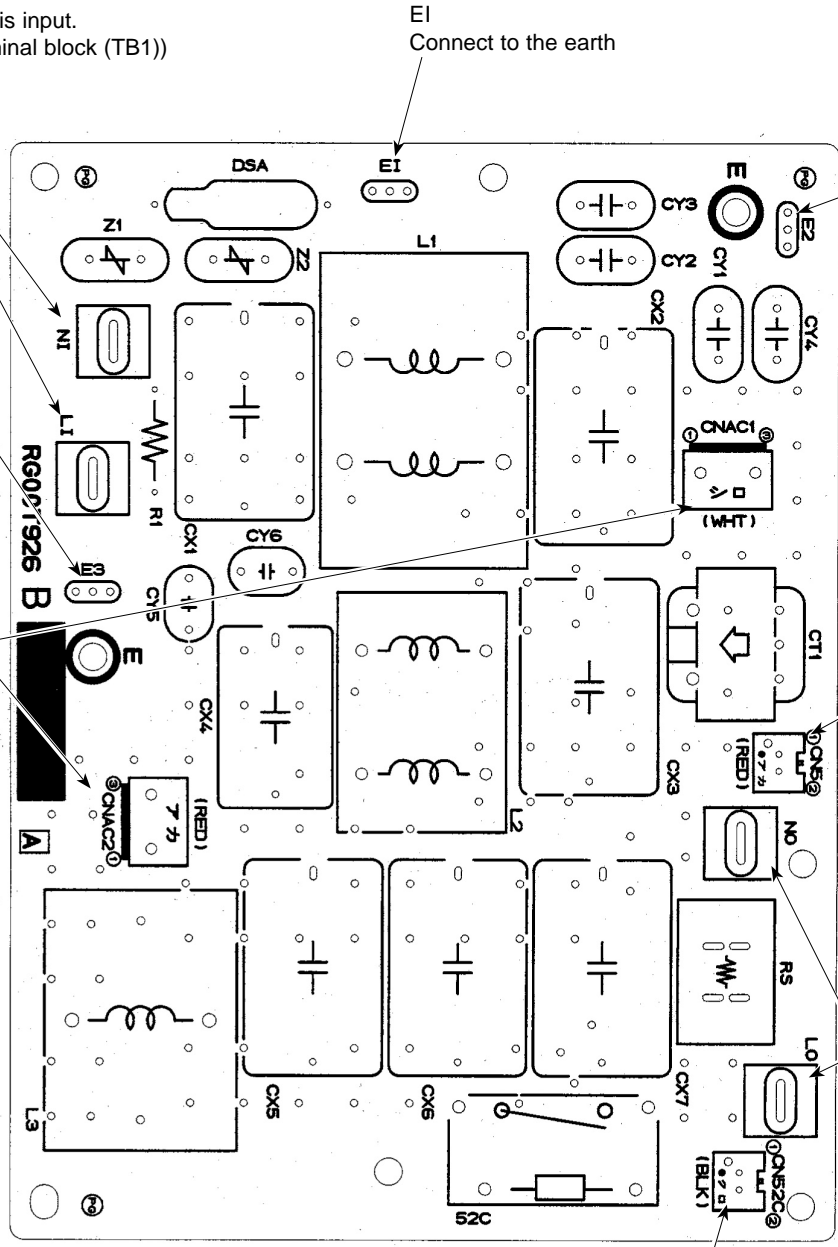

Outdoor power circuit board
PUHZ-SW40VHA
PUHZ-SW40VHA-BS
PUHZ-SW50VHA
PUHZ-SW50VHA-BS

Brief Check of DIP-IPM and DIP-PFC
 * Usually, they are in a state of being short-circuited if they are broken.
 Measure the resistance in the following points (connectors, etc.). If they are short-circuited, it means that they are broken.
 1. Check of DIP-IPM
 [P2]-[U], [P2]-[V], [P2]-[W], [N2]-[U], [N2]-[V], [N2]-[W]
 2. Check of DIP-PFC
 [P1]-[L], [P1]-[N], [L]-[N1], [N]-[N1]
 Note: The marks, [L], [N], [N1], [N2], [P1], [P2], [U], [V] and [W] shown in the diagram are not actually printed on the board.

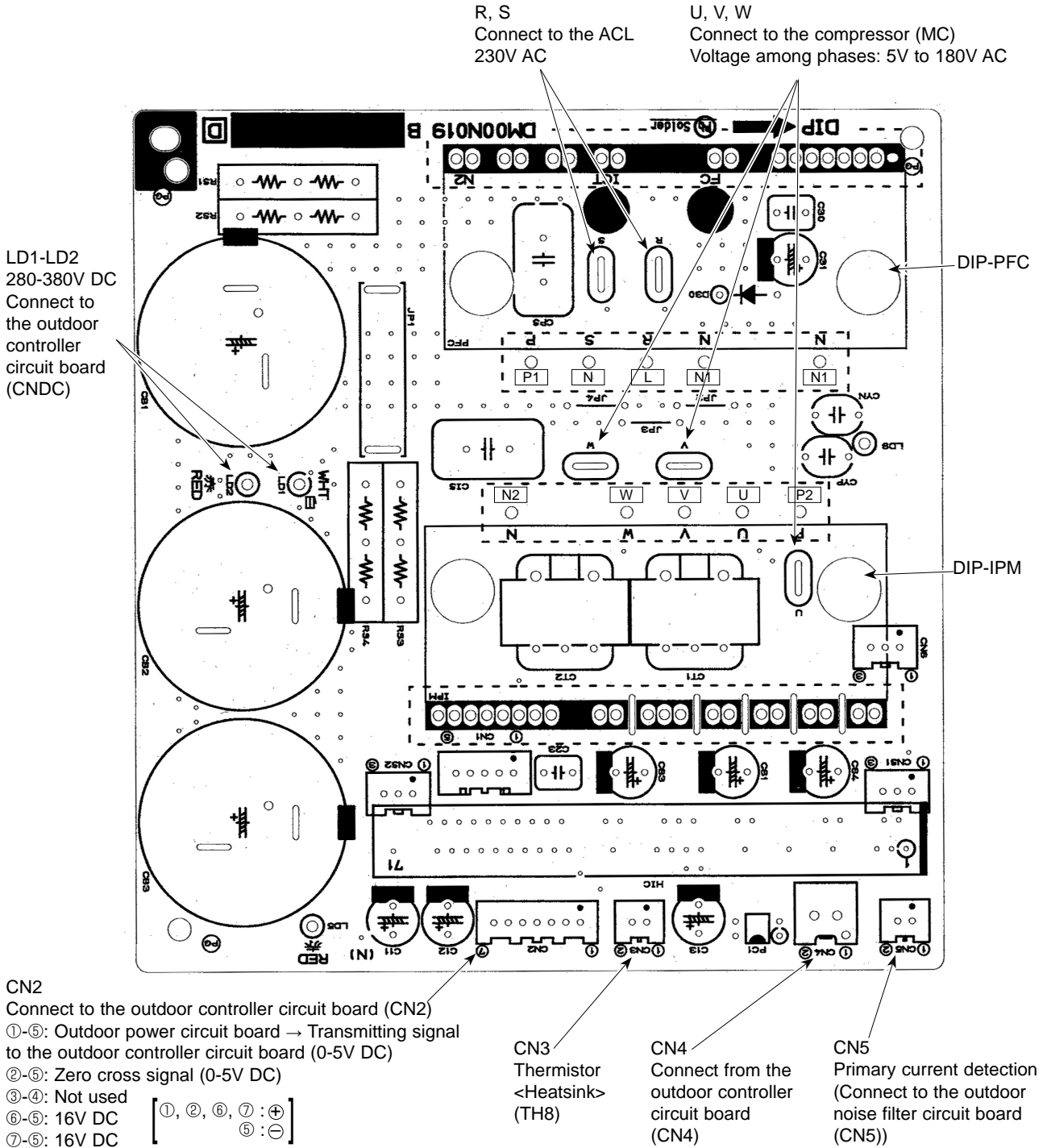

10-10. FUNCTION OF SWITCHES, CONNECTORS AND JUMPERS

(1) Function of switches

The black square (■) indicates a switch position.

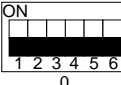
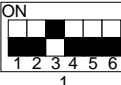
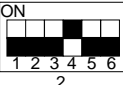
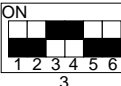
Type of Switch	Switch	No.	Function	Action by the switch operation		Effective timing																																																																																		
				ON	OFF																																																																																			
Dip switch	SW1	1	Forced defrost *1	Start	Normal	When compressor is working in heating operation. *1																																																																																		
		2	Abnormal history clear	Clear	Normal	OFF or operating																																																																																		
		3	Refrigerant address setting		0	When power supply ON																																																																																		
		4			1																																																																																			
		5			2																																																																																			
		6			3																																																																																			
	SW4	1	Test run	Operating	OFF	Under suspension																																																																																		
		2	Test run mode setting	Heating	Cooling																																																																																			
Push switch	SWP		Pump down	Start	Normal	Under suspension																																																																																		
Dip switch	SW5	1	No function	—	—	—																																																																																		
		2	Power failure automatic recovery *2	Auto recovery	No auto recovery	When power supply ON																																																																																		
		3,4,5	No function	—	—	—																																																																																		
		6	Model select	Following SW5-6 reference																																																																																				
	SW7 *4	1	Mode select *3	Demand function	Low noise mode	Always																																																																																		
		2	No function	—	—	—																																																																																		
		3	Max Hz setting (cooling)	Max Hz (cooling) × 0.8	Normal	Always																																																																																		
		4	Max Hz setting (heating)	Max Hz (heating) × 0.8	Normal	Always																																																																																		
		5	Breaker capacity setting *5	16A	25A	When power supply ON																																																																																		
		6	Defrost setting	For high humidity	Normal	Always																																																																																		
	SW8	1	No function	—	—	—																																																																																		
		2	No function	—	—	—																																																																																		
		3	No function	—	—	—																																																																																		
	SW9	1	No function	—	—	—																																																																																		
		2	Function switch	Valid	Normal	Always																																																																																		
		3,4	No function	—	—	—																																																																																		
	SW6	1	Model select	<table border="1" data-bbox="721 1331 1146 1482"> <thead> <tr> <th>MODEL</th> <th colspan="8">SW6</th> <th colspan="6">SW5-6</th> </tr> </thead> <tbody> <tr> <td rowspan="2">40</td> <td>ON</td> <td>■</td><td>■</td><td>■</td><td>■</td><td>■</td><td>■</td><td>■</td><td>■</td> <td>OFF</td> <td>□</td><td>□</td><td>□</td><td>□</td><td>□</td><td>■</td> </tr> <tr> <td>OFF</td> <td>□</td><td>□</td><td>□</td><td>□</td><td>□</td><td>□</td><td>□</td><td>□</td> <td>OFF</td> <td>□</td><td>□</td><td>□</td><td>□</td><td>□</td><td>□</td> </tr> <tr> <td rowspan="2">50</td> <td>ON</td> <td>■</td><td>■</td><td>■</td><td>■</td><td>■</td><td>■</td><td>■</td><td>■</td> <td>OFF</td> <td>□</td><td>□</td><td>□</td><td>□</td><td>□</td><td>■</td> </tr> <tr> <td>OFF</td> <td>□</td><td>□</td><td>□</td><td>□</td><td>□</td><td>□</td><td>□</td><td>□</td> <td>OFF</td> <td>□</td><td>□</td><td>□</td><td>□</td><td>□</td><td>□</td> </tr> </tbody> </table> <p>The black square (■) indicates a switch position.</p>				MODEL	SW6								SW5-6						40	ON	■	■	■	■	■	■	■	■	OFF	□	□	□	□	□	■	OFF	□	□	□	□	□	□	□	□	OFF	□	□	□	□	□	□	50	ON	■	■	■	■	■	■	■	■	OFF	□	□	□	□	□	■	OFF	□	□	□	□	□	□	□	□	OFF	□	□	□	□	□	□
		MODEL						SW6								SW5-6																																																																								
40		ON						■	■	■	■	■	■	■	■	OFF	□	□	□	□	□	■																																																																		
		OFF						□	□	□	□	□	□	□	□	OFF	□	□	□	□	□	□																																																																		
50		ON						■	■	■	■	■	■	■	■	OFF	□	□	□	□	□	■																																																																		
		OFF						□	□	□	□	□	□	□	□	OFF	□	□	□	□	□	□																																																																		
2																																																																																								
3																																																																																								
4																																																																																								
5																																																																																								
6																																																																																								
7																																																																																								
8																																																																																								
SW5	6																																																																																							

*1 Forced defrost should be done as follows.

① Change the DIP SW1-1 on the outdoor controller board from OFF to ON.

② Forced defrost will start by the above operation ① if all these conditions written below are satisfied.

- Heat mode setting
- 10 minutes have passed since compressor started operating or previous compulsory defrosting finished.
- Pipe temperature is less than or equal to 8°C.

Forced defrost will finish if certain conditions are satisfied.

Forced defrost can be done if above conditions are satisfied when DIP SW1-1 is changed from OFF to ON.

After DIP SW1-1 is changed from OFF to ON, there is no problem if DIP SW1-1 is left ON or changed to OFF again.

This depends on the service conditions.

*2 'Power failure automatic recovery' can be set by either remote controller or this DIP SW. If one of them is set to ON, 'Auto recovery' activates. Please set "Auto recovery" basically by remote controller because all units do not have DIP SW.

Please refer to the indoor unit installation manual.

*3 SW7-1 is setting change over of Demand/Low noise. It is effective only in case of external input.

(Local wiring is necessary. Refer to next page: Special function)

*4 Please do not use SW7-3 to SW7-6 usually. Trouble might be caused by the usage condition.

*5 With this switch setting, the capacity decreases up to 30% under peak load condition. Thus this setting is recommended only for Air to water purposes.

(2) Function of connector

Types	Connector	Function	Action by open/ short operation		Effective timing
			Short	Open	
Connector	CN31	Emergency operation	Start	Normal	When power supply ON

Special function

(a) Low-level sound priority mode (Local wiring)

Unit enters into Low-level sound priority mode by external signal input setting.

Inputting external signals to the outdoor unit decreases the outdoor unit operation sound 3 to 4 dB lower than that of usual. Adding a commercial timer or on-off switch contactor setting to the CNNDM connector which is optional contactor for demand input located on the outdoor controller board enables to control compressor operation frequency.

* The performance depends on the load of conditioned outdoor temperature.

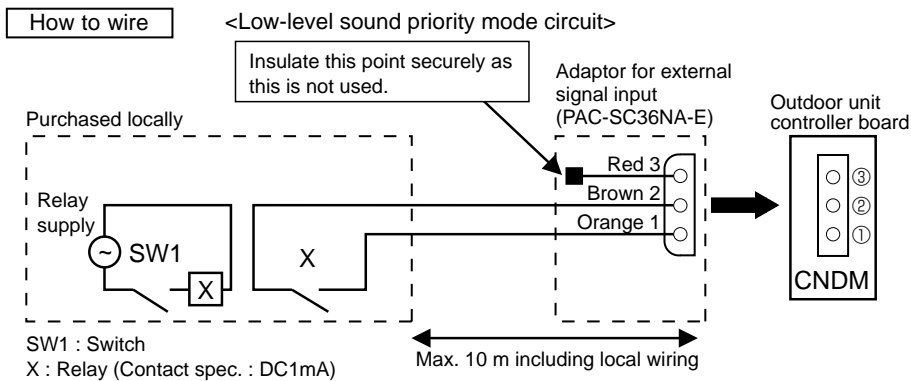

1) Make the circuit as shown above with Adaptor for external signal input (PAC-SC36NA-E).

2) Turn SW1 to on for Low-level sound priority mode.

Turn SW1 to off to release Low-level sound priority mode and normal operation.

(b) On demand control (Local wiring)

Demand control is available by external input. In this mode, power consumption is decreased within the range of usual 0~100%.

How to wire

Basically, the wiring is the same as (a).

Connect an SW 1 which is procured at field to the between Orange and Red (1 and 3) of the Adaptor for external signal input (PAC-SC36NA-E), and insulate the tip of the brown lead wire.

It is possible to set it to the following power consumption (compared with ratings) by setting the SW7-1, 2.

SW7-1	SW7-2	Power consumption (SW1 on)
OFF	OFF	0% (Operation stop)
ON	OFF	50%
OFF	ON	75%

<Display function of inspection for outdoor unit>

The blinking patterns of both LED1 (green) and LED2 (red) indicate the types of abnormality when it occurs. Types of abnormality can be indicated in details by connecting an optional part 'A-Control Service Tool (PAC-SK52ST)' to connector CNM on outdoor controller board.

[Display]

(1) Normal condition

Unit condition	Outdoor controller board		A-Control Service Tool	
	LED1 (Green)	LED2 (Red)	Error code	Indication of the display
When the power is turned on	Lighted	Lighted	— ⇄ —	Alternately blinking display
When unit stops	Lighted	Not lighted	00, etc.	Operation mode
When compressor is warming up	Lighted	Not lighted	08, etc.	
When unit operates	Lighted	Lighted	C5, H7 etc.	

(2) Abnormal condition

Indication		Contents	Error		
Outdoor controller board			Error code *1	Inspection method	Detailed reference page
LED1 (Green)	LED2 (Red)				
1 blinking	2 blinking	Connector (63H) is open.	F5	①Check if connector (63H) on the outdoor controller board is not disconnected. ②Check continuity of pressure switch (63H) by tester.	P.15
2 blinking	1 blinking	Miswiring of I/F or FTC or outdoor unit connecting wire, excessive number of indoor units (4 units or more)	—	①Check if I/F or FTC or outdoor connecting wire is connected correctly. ②Check if 4 or more I/F or FTC units are connected to outdoor unit. ③Check if noise entered into I/F or FTC or outdoor connecting wire or power supply. ④Re-check error by turning off power, and on again.	
		Miswiring of I/F or FTC or outdoor unit connecting wire (converse wiring or disconnection)	—		
		Startup time over	—		
	2 blinking	I/F or FTC or outdoor unit communication error (signal receiving error) is detected by FTC unit.	E6	①Check if I/F or FTC or outdoor connecting wire is connected correctly. ②Check if noise entered into I/F or FTC or outdoor connecting wire or power supply. ③Check if noise entered into I/F or FTC or outdoor controller board. ④Re-check error by turning off power, and on again.	P.22
		I/F or FTC or outdoor unit communication error (signal receiving error) is detected by outdoor unit.	(E8)		
		I/F or FTC or outdoor unit communication error (transmitting error) is detected by outdoor unit.	(E9)		
	3 blinking	Remote controller signal receiving error is detected by remote controller.	E0	①Check if connecting wire of I/F or FTC unit or remote controller is connected correctly. ②Check if noise entered into transmission wire of remote controller. ③Re-check error by turning off power, and on again.	P.21
		Remote controller transmitting error is detected by remote controller.	E3		
		Remote controller signal receiving error is detected by I/F or FTC unit.	E4		
		Remote controller transmitting error is detected by I/F or FTC unit.	E5		
	4 blinking	Error code is not defined.	EF	①Check if noise entered into transmission wire of remote controller. ②Check if noise entered into I/F or FTC or outdoor connecting wire. ③Re-check error by turning off power, and on again.	P.22

*1 Error code displayed on remote controller

*2 Refer to Technical manual of ATW, I/F, FTC.



Indication		Error				
Outdoor controller board		Contents	Error code *1	Inspection method	Detailed reference page	
LED1 (Green)	LED2 (Red)					
3 blinking	1 blinking	Abnormality of comp.surface thermistor(TH34) and discharging temperature (TH4)	U2	①Check if stop valves are open. ②Check if connectors (TH4, TH34, LEV-A, and LEV-B) on outdoor controller board are not disconnected. ③Check if unit is filled with specified amount of refrigerant. ④Measure resistance values among terminals on indoor valve and outdoor linear expansion valve using a tester.	P.17	
		Abnormality of superheat due to low discharge temperature	U7		P.18	
	2 blinking	Abnormal high pressure (High pressure switch 63H operated.)		U1	①Check if indoor/outdoor units have a short cycle on their air ducts. ②Check if connector (63H) on outdoor controller board is not disconnected. ③Check if heat exchanger and filter is not dirty. ④Measure resistance values among terminals on linear expansion valve using a tester.	P.17
		3 blinking	Abnormality of outdoor fan motor rotational speed	U8		
	Protection from overheat operation(TH3)		Ud	P.20		
	4 blinking	Compressor overcurrent breaking(Start-up locked)		UF	①Check if stop valves are open. ②Check looseness, disconnection, and converse connection of compressor wiring. ③Measure resistance values among terminals on compressor using a tester. ④Check if outdoor unit has a short cycle on its air duct.	P.20
		Compressor overcurrent breaking		UP		
		Abnormality of current sensor (P.B.)		UH		
		Abnormality of power module		U6		
	5 blinking	Open/short of discharge thermistor (TH4) and comp.surface thermistor (TH34)		U3	①Check if connectors(TH3,TH4,TH6 ,TH7 and TH34)on outdoor controller board and connector (CN3) on outdoor power board are not disconnected. ②Measure resistance value of outdoor thermistors.	P.17
		Open/short of outdoor thermistors (TH3, TH6, TH7 and TH8)		U4		P.18
	6 blinking	Abnormality of heatsink temperature		U5	①Check if indoor/outdoor units have a short cycle on their air ducts. ②Measure resistance value of outdoor thermistor(TH8).	P.18
	7 blinking	Abnormality of voltage		U9	①Check looseness, disconnection, and converse connection of compressor wiring. ②Measure resistance value among terminals on compressor using a tester. ③Check the continuity of contactor (52C). ④Check if power supply voltage decreases. ⑤Check the wiring of CN52C. ⑥Check the wiring of CNAF.	P.19
4 blinking	1 blinking	Abnormality of room temperature thermistor (TH1)	P1	①Check if connectors (CN20, CN21, CN29 and CN44) on indoor controller board are not disconnected. ②Measure resistance value of indoor thermistors.	*2	
		Abnormality of pipe temperature thermistor /Liquid (TH2)	P2		*2	
		Abnormality of pipe temperature thermistor/Condenser-Evaporator	P9		*2	
	2 blinking	Abnormality of drain sensor (DS) Float switch(FS) connector open		P4	①Check if connector (CN31)(CN4F) on indoor controller board is not disconnected. ②Measure resistance value of indoor thermistors. ③Measure resistance value among terminals on drain pump using a tester. ④Check if drain pump works. ⑤Check drain function.	*2
		Indoor drain overflow protection		P5		
	3 blinking	Freezing (cooling)/overheating (heating) protection		P6	①Check if indoor unit has a short cycle on its air duct. ②Check if heat exchanger and filter is not dirty. ③Measure resistance value on indoor and outdoor fan motors. ④Check if the inside of refrigerant piping is not clogged.	*2
	4 blinking	Abnormality of pipe temperature		P8	①Check if indoor thermistors(TH2 and TH5) are not disconnected from holder. ②Check if stop valve is open. ③Check converse connection of extension pipe. (on plural units connection) ④Check if indoor/outdoor connecting wire is connected correctly. (on plural units connection)	*2

*1 Error code displayed on remote controller

*2 Refer to service manual for indoor unit.

<Outdoor unit operation monitor function>

[When optional part 'A-Control Service Tool (PAC-SK52ST)' is connected to outdoor controller board (CNM)]

Digital indicator LED1 displays 2 digit number or code to inform operation condition and the meaning of error code by controlling DIP SW2 on 'A-Control Service Tool'.

Operation indicator SW2 : Indicator change of self diagnosis

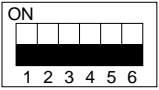
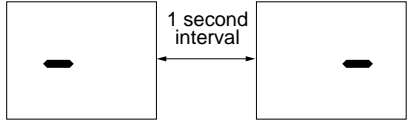
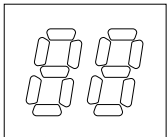
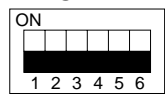
SW2 setting	Display detail	Explanation for display	Unit																																																																	
	<p><Digital indicator LED1 working details> (Be sure that the 1 to 6 in the SW2 are set to OFF.)</p> <p>(1) Display when the power supply ON When the power supply ON, blinking displays by turns. Wait for 4 minutes at the longest.</p> <p>(2) When the display lights (Normal operation)</p> <p>① Operation mode display.</p>																																																																			
	<p>LED1</p>  <p>(Lighting)</p>	<p>SW2</p>  <p>(Initial setting)</p>																																																																		
	<p>The tens digit : Operation mode</p> <table border="1"> <thead> <tr> <th>Display</th> <th>Operation Model</th> </tr> </thead> <tbody> <tr> <td>O</td> <td>OFF / FAN</td> </tr> <tr> <td>C</td> <td>COOLING / DRY *</td> </tr> <tr> <td>H</td> <td>HEATING</td> </tr> <tr> <td>d</td> <td>DEFROSTING</td> </tr> </tbody> </table>	Display	Operation Model	O	OFF / FAN	C	COOLING / DRY *	H	HEATING	d	DEFROSTING	<p>The ones digit : Relay output</p> <table border="1"> <thead> <tr> <th>Display</th> <th>Warming-up Compressor</th> <th>Compressor</th> <th>4-way valve</th> <th>Solenoid valve</th> </tr> </thead> <tbody> <tr> <td>0</td> <td>—</td> <td>—</td> <td>—</td> <td>—</td> </tr> <tr> <td>1</td> <td>—</td> <td>—</td> <td>—</td> <td>ON</td> </tr> <tr> <td>2</td> <td>—</td> <td>—</td> <td>ON</td> <td>—</td> </tr> <tr> <td>3</td> <td>—</td> <td>—</td> <td>ON</td> <td>ON</td> </tr> <tr> <td>4</td> <td>—</td> <td>ON</td> <td>—</td> <td>—</td> </tr> <tr> <td>5</td> <td>—</td> <td>ON</td> <td>—</td> <td>ON</td> </tr> <tr> <td>6</td> <td>—</td> <td>ON</td> <td>ON</td> <td>—</td> </tr> <tr> <td>7</td> <td>—</td> <td>ON</td> <td>ON</td> <td>ON</td> </tr> <tr> <td>8</td> <td>ON</td> <td>—</td> <td>—</td> <td>—</td> </tr> <tr> <td>A</td> <td>ON</td> <td>—</td> <td>ON</td> <td>—</td> </tr> </tbody> </table>	Display	Warming-up Compressor	Compressor	4-way valve	Solenoid valve	0	—	—	—	—	1	—	—	—	ON	2	—	—	ON	—	3	—	—	ON	ON	4	—	ON	—	—	5	—	ON	—	ON	6	—	ON	ON	—	7	—	ON	ON	ON	8	ON	—	—	—	A	ON	—	ON	—	
Display	Operation Model																																																																			
O	OFF / FAN																																																																			
C	COOLING / DRY *																																																																			
H	HEATING																																																																			
d	DEFROSTING																																																																			
Display	Warming-up Compressor	Compressor	4-way valve	Solenoid valve																																																																
0	—	—	—	—																																																																
1	—	—	—	ON																																																																
2	—	—	ON	—																																																																
3	—	—	ON	ON																																																																
4	—	ON	—	—																																																																
5	—	ON	—	ON																																																																
6	—	ON	ON	—																																																																
7	—	ON	ON	ON																																																																
8	ON	—	—	—																																																																
A	ON	—	ON	—																																																																
	<p>*C5 is displayed during replacement operation.</p> <p>② Display during error postponement Postponement code is displayed when compressor stops due to the work of protection device. Postponement code is displayed while error is being postponed.</p> <p>(3) When the display blinks Inspection code is displayed when compressor stops due to the work of protection devices.</p>																																																																			
	<table border="1"> <thead> <tr> <th>Display</th> <th>Inspection unit</th> </tr> </thead> <tbody> <tr> <td>0</td> <td>Outdoor unit</td> </tr> <tr> <td>1</td> <td>Indoor unit 1</td> </tr> <tr> <td>2</td> <td>Indoor unit 2</td> </tr> <tr> <td>3</td> <td>Indoor unit 3</td> </tr> <tr> <td>4</td> <td>Indoor unit 4</td> </tr> </tbody> </table>	Display	Inspection unit	0	Outdoor unit	1	Indoor unit 1	2	Indoor unit 2	3	Indoor unit 3	4	Indoor unit 4	<table border="1"> <thead> <tr> <th>Display</th> <th>Contents to be inspected (During operation)</th> </tr> </thead> <tbody> <tr> <td>U1</td> <td>Abnormal high pressure (63H operated)</td> </tr> <tr> <td>U2</td> <td>Abnormal high discharging temperature and shell thermistor, shortage of refrigerant</td> </tr> <tr> <td>U3</td> <td>Open/short circuit of discharging thermistor (TH4) and comp.surface thermistor (TH34)</td> </tr> <tr> <td>U4</td> <td>Open/short of outdoor unit thermistors (TH3, TH6, TH7 and TH8)</td> </tr> <tr> <td>U5</td> <td>Abnormal temperature of heatsink</td> </tr> <tr> <td>U6</td> <td>Abnormality of power module</td> </tr> <tr> <td>U7</td> <td>Abnormality of superheat due to low discharge temperature</td> </tr> <tr> <td>U8</td> <td>Abnormality in outdoor fan motor</td> </tr> <tr> <td>Ud</td> <td>Overheat protection</td> </tr> <tr> <td>UF</td> <td>Compressor overcurrent interruption (When Comp. locked)</td> </tr> <tr> <td>UH</td> <td>Current sensor error</td> </tr> <tr> <td>UL</td> <td>Abnormal low pressure</td> </tr> <tr> <td>UP</td> <td>Compressor overcurrent interruption</td> </tr> <tr> <td>P1-P8</td> <td>Abnormality of indoor units</td> </tr> <tr> <td>A0-A7</td> <td>Communication error of M-NET system</td> </tr> </tbody> </table>	Display	Contents to be inspected (During operation)	U1	Abnormal high pressure (63H operated)	U2	Abnormal high discharging temperature and shell thermistor, shortage of refrigerant	U3	Open/short circuit of discharging thermistor (TH4) and comp.surface thermistor (TH34)	U4	Open/short of outdoor unit thermistors (TH3, TH6, TH7 and TH8)	U5	Abnormal temperature of heatsink	U6	Abnormality of power module	U7	Abnormality of superheat due to low discharge temperature	U8	Abnormality in outdoor fan motor	Ud	Overheat protection	UF	Compressor overcurrent interruption (When Comp. locked)	UH	Current sensor error	UL	Abnormal low pressure	UP	Compressor overcurrent interruption	P1-P8	Abnormality of indoor units	A0-A7	Communication error of M-NET system																						
Display	Inspection unit																																																																			
0	Outdoor unit																																																																			
1	Indoor unit 1																																																																			
2	Indoor unit 2																																																																			
3	Indoor unit 3																																																																			
4	Indoor unit 4																																																																			
Display	Contents to be inspected (During operation)																																																																			
U1	Abnormal high pressure (63H operated)																																																																			
U2	Abnormal high discharging temperature and shell thermistor, shortage of refrigerant																																																																			
U3	Open/short circuit of discharging thermistor (TH4) and comp.surface thermistor (TH34)																																																																			
U4	Open/short of outdoor unit thermistors (TH3, TH6, TH7 and TH8)																																																																			
U5	Abnormal temperature of heatsink																																																																			
U6	Abnormality of power module																																																																			
U7	Abnormality of superheat due to low discharge temperature																																																																			
U8	Abnormality in outdoor fan motor																																																																			
Ud	Overheat protection																																																																			
UF	Compressor overcurrent interruption (When Comp. locked)																																																																			
UH	Current sensor error																																																																			
UL	Abnormal low pressure																																																																			
UP	Compressor overcurrent interruption																																																																			
P1-P8	Abnormality of indoor units																																																																			
A0-A7	Communication error of M-NET system																																																																			
	<table border="1"> <thead> <tr> <th>Display</th> <th>Contents to be inspected (When power is turned on)</th> </tr> </thead> <tbody> <tr> <td>F3</td> <td>63L connector (red) is open.</td> </tr> <tr> <td>F5</td> <td>63H connector (yellow) is open.</td> </tr> <tr> <td>F9</td> <td>2 connectors (63H) are open.</td> </tr> <tr> <td>E8</td> <td>Indoor/outdoor communication error (Signal receiving error) (Outdoor unit)</td> </tr> <tr> <td>E9</td> <td>Indoor/outdoor communication error (Transmitting error) (Outdoor unit)</td> </tr> <tr> <td>EA</td> <td>Miswiring of indoor/outdoor unit connecting wire, excessive number of indoor units (4 units or more)</td> </tr> <tr> <td>Eb</td> <td>Miswiring of indoor/outdoor unit connecting wire (converse wiring or disconnection)</td> </tr> <tr> <td>EC</td> <td>Startup time over</td> </tr> <tr> <td>E0-E7</td> <td>Communication error except for outdoor unit</td> </tr> </tbody> </table>	Display	Contents to be inspected (When power is turned on)	F3	63L connector (red) is open.	F5	63H connector (yellow) is open.	F9	2 connectors (63H) are open.	E8	Indoor/outdoor communication error (Signal receiving error) (Outdoor unit)	E9	Indoor/outdoor communication error (Transmitting error) (Outdoor unit)	EA	Miswiring of indoor/outdoor unit connecting wire, excessive number of indoor units (4 units or more)	Eb	Miswiring of indoor/outdoor unit connecting wire (converse wiring or disconnection)	EC	Startup time over	E0-E7	Communication error except for outdoor unit																																															
Display	Contents to be inspected (When power is turned on)																																																																			
F3	63L connector (red) is open.																																																																			
F5	63H connector (yellow) is open.																																																																			
F9	2 connectors (63H) are open.																																																																			
E8	Indoor/outdoor communication error (Signal receiving error) (Outdoor unit)																																																																			
E9	Indoor/outdoor communication error (Transmitting error) (Outdoor unit)																																																																			
EA	Miswiring of indoor/outdoor unit connecting wire, excessive number of indoor units (4 units or more)																																																																			
Eb	Miswiring of indoor/outdoor unit connecting wire (converse wiring or disconnection)																																																																			
EC	Startup time over																																																																			
E0-E7	Communication error except for outdoor unit																																																																			





The black square (■) indicates a switch position.

SW2 setting	Display detail	Explanation for display	Unit
	Pipe temperature / Liquid (TH3) -40 – 90	-40 – 90 (When the coil thermistor detects 0°C or below, “-” and temperature are displayed by turns.) (Example) When -10°C; 0.5 secs. 0.5secs. 2 secs. -□ → 10 → □□	°C
	Discharge temperature (TH4) 3 – 217	3 – 217 (When the discharge thermistor detects 100°C or more, hundreds digit, tens digit and ones digit are displayed by turns.) (Example) When 105°C; 0.5 secs. 0.5secs. 2 secs. □1 → 05 → □□	°C
	Output step of outdoor FAN 0 – 10	0 – 10	Step
	The number of ON / OFF times of compressor 0 – 9999	0 – 9999 (When the number of times is 100 or more, hundreds digit, tens digit and ones digit are displayed by turns.) (Example) When 42500 times (425 × 100 times); 0.5 secs. 0.5secs. 2 secs. □4 → 25 → □□	100 times
	Compressor integrating operation times 0 – 9999	0 – 9999 (When it is 100 hours or more, hundreds digit, tens digit and ones digit are displayed by turns.) (Example) When 2450 hours (245 × 10 hours); 0.5 secs. 0.5secs. 2 secs. □2 → 45 → □□	10 hours
	Compressor operating current 0 – 50	0 – 50 *Omit the figures after the decimal fractions.	A
	Compressor operating frequency 0 – 255	0 – 255 (When it is 100Hz or more, hundreds digit, tens digit and ones digit are displayed by turns.) (Example) When 125Hz; 0.5 secs. 0.5secs. 2 secs. □1 → 25 → □□	Hz
	LEV-A opening pulse 0 – 480	0 – 480 (When it is 100 pulse or more, hundreds digit, tens digit and ones digit are displayed by turns.) (Example) When 150 pulse; 0.5 secs. 0.5secs. 2 secs. □1 → 50 → □□	Pulse
	Error postponement code history (1) of outdoor unit	Postponement code display Blinking: During postponement Lighting: Cancellation of postponement “00” is displayed in case of no postponement.	Code display
	Operation mode on error occurring	Operation mode of when operation stops due to error is displayed by setting SW2 like below. (SW2)	Code display

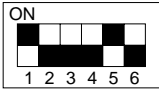
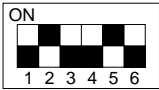
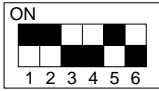

The black square (■) indicates a switch position.

SW2 setting	Display detail	Explanation for display	Unit
	Pipe temperature / Liquid (TH3) on error occurring -40 – 90	– 40~90 (When the coil thermistor detects 0°C or below, “–” and temperature are displayed by turns.) (Example) When -15°C; 0.5 secs. 0.5secs. 2 secs. -□ → 15 → □□	°C
	Discharge temperature (TH4) on error occurring 3 – 217	3~217 (When the temperature is 100°C or more, the hundreds digit, tens digit and ones digit are displayed by turns.) (Example) When 130°C; 0.5 secs. 0.5secs. 2 secs. □1 → 30 → □□	°C
	Compressor operating current on error occurring 0 – 50	0~50	A
	Error code history (1) (latest) Alternate display of abnormal unit number and code	When no error history, “0” and “– –” are displayed by turns.	Code display
	Error code history (2) Alternate display of error unit number and code	When no error history, “0” and “– –” are displayed by turns.	Code display
	Thermostat ON time 0 – 999	0~999 (When it is 100 minutes or more, the hundreds digit, tens digit and ones digit are displayed by turns.) (Example) When 245 minutes; 0.5 secs. 0.5secs. 2 secs. □2 → 45 → □□	Minute
	Test run elapsed time 0 – 120	0~120 (When it is 100 minutes or more, the hundreds digit, tens digit and ones digit are displayed by turns.) (Example) When 105 minutes; 0.5 secs. 0.5secs. 2 secs. □1 → 05 → □□	Minute

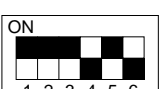
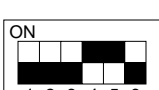
The black square (■) indicates a switch position.

SW2 setting	Display detail	Explanation for display	Unit										
	The number of connected indoor units	0 – 4 (The number of connected indoor units are displayed.)	Unit										
	Capacity setting display	Displayed as an outdoor capacity code. <table border="1" data-bbox="865 478 1099 562"> <thead> <tr> <th>Capacity</th> <th>Code</th> </tr> </thead> <tbody> <tr> <td>SW40V</td> <td>9</td> </tr> <tr> <td>SW50V</td> <td>10</td> </tr> </tbody> </table>	Capacity	Code	SW40V	9	SW50V	10	Code display				
Capacity	Code												
SW40V	9												
SW50V	10												
	Outdoor unit setting information	<ul style="list-style-type: none"> The tens digit (Total display for applied setting) <table border="1" data-bbox="834 709 1367 823"> <thead> <tr> <th>Setting details</th> <th>Display details</th> </tr> </thead> <tbody> <tr> <td>H·P / Cooling only</td> <td>0 : H·P 1 : Cooling only</td> </tr> <tr> <td>Single phase / 3 phase</td> <td>0 : Single phase 2 : 3 phase</td> </tr> </tbody> </table> <ul style="list-style-type: none"> The ones digit <table border="1" data-bbox="834 873 1367 953"> <thead> <tr> <th>Setting details</th> <th>Display details</th> </tr> </thead> <tbody> <tr> <td>Defrosting switch</td> <td>0 : Normal 1 : For high humidity</td> </tr> </tbody> </table> <p>(Example) When heat pump, 3 phase and defrosting (normal) are set up, “20” is displayed.</p>	Setting details	Display details	H·P / Cooling only	0 : H·P 1 : Cooling only	Single phase / 3 phase	0 : Single phase 2 : 3 phase	Setting details	Display details	Defrosting switch	0 : Normal 1 : For high humidity	Code display
Setting details	Display details												
H·P / Cooling only	0 : H·P 1 : Cooling only												
Single phase / 3 phase	0 : Single phase 2 : 3 phase												
Setting details	Display details												
Defrosting switch	0 : Normal 1 : For high humidity												
	Indoor pipe temperature / Liquid (TH2(1)) Indoor 1 -39 – 88	-39 – 88 (When the temperature is 0°C or less, “-” and temperature are displayed by turns.)	°C										
	Indoor pipe temperature / Cond. / Eva. (TH5(1)) Indoor 1 -39 – 88	-39 – 88 (When the temperature is 0°C or less, “-” and temperature are displayed by turns.)	°C										
	Indoor pipe temperature / Liquid (TH2(2)) Indoor 2 -39 – 88	-39 – 88 (When the temperature is 0°C or less, “-” and temperature are displayed by turns.)	°C										
	Indoor pipe temperature / Cond. / Eva. (TH5(2)) Indoor 2 -39 – 88	-39 – 88 (When the temperature is 0°C or less, “-” and temperature are displayed by turns.)	°C										
	Indoor room temperature (TH1) 8 – 39	8 – 39	°C										

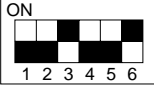
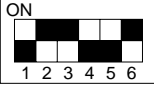
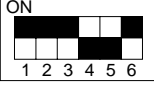
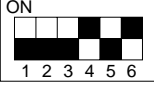
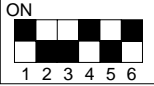
The black square (■) indicates a switch position.

SW2 setting	Display detail	Explanation for display	Unit
	DC bus voltage 180 – 370	180~370 (When it is 100V or more, hundreds digit, tens digit and ones digit are displayed by turns.)	V
	Error postponement code history (2) of outdoor unit	Postponement code display Blinking: During postponement Lighting: Cancellation of postponement "00" is displayed in case of no postponement.	Code display
	Error postponement code history (3) of outdoor unit	Postponement code display Blinking: During postponement Lighting: Cancellation of postponement "00" is displayed in case of no postponement.	Code display
	Error code history (3) (Oldest) Alternate display of abnormal unit number and code.	When no error history, "0" and "--" are displayed by turns.	Code display
	Error thermistor display [When there is no error thermistor, "--" is displayed.]	3: Liquid pipe temperature (TH3) 4: Discharge pipe thermistor (TH4) 6: 2-phase pipe thermistor (TH6) 7: Ambient temp. thermistor (TH7) 8: Heatsink thermistor (TH8) 34: Comp. surface thermistor (TH34)	Code display
	Operation frequency on error occurring 0 – 255	0 – 255 (When it is 100Hz or more, hundreds digit, tens digit and ones digit are displayed by turns.) (Example) When 125Hz; 0.5 secs. 0.5secs. 2 secs. □1 → 25 → □□ ↑	Hz
	Fan step on error occurring 0 – 10	0 – 10	Step

The black square (■) indicates a switch position.

SW2 setting	Display detail	Explanation for display	Unit
	LEV-A opening pulse on error occurring 0 – 480	0 – 480 (When it is 100 pulse or more, hundreds digit, tens digit and ones digit are displayed by turns.) (Example) When 130 pulse; 0.5 secs. 0.5secs. 2 secs. □1 → 30 → □□ ↑	Pulse
	Indoor room temperature (TH1) on error occurring 8 – 39	8 – 39	°C
	Indoor pipe temperature / Liquid (TH2) on error occurring -39 – 88	-39 – 88 (When the temperature is 0°C or less, “-” and temperature are displayed by turns.) (Example) When -15°C; 0.5 secs. 0.5secs. 2 secs. -□ → 15 → □□ ↑	°C
	Pressure saturation temperature (T _{63HS}) on error occurring -39 – 88	-39 – 88 (When the temperature is 0°C or less, “-” and temperature are displayed by turns.) (Example) When -15°C; 0.5 secs. 0.5secs. 2 secs. -□ → 15 → □□ ↑	°C
	Outdoor pipe temperature / 2-phase (TH6) on error occurring -39 – 88	-39 – 88 (When the temperature is 0°C or less, “-” and temperature are displayed by turns.) (Example) When -15°C; 0.5 secs. 0.5secs. 2 secs. -□ → 15 → □□ ↑	°C
	Outdoor ambient temperature (TH7) on error occurring -39 – 88	-39 – 88 (When the temperature is 0°C or less, “-” and temperature are displayed by turns.) (Example) When -15°C; 0.5 secs. 0.5secs. 2 secs. -□ → 15 → □□ ↑	°C
	Outdoor heatsink temperature (TH8) on error occurring -40 – 200	-40 – 200 (When the temperature is 0°C or less, “-” and temperature are displayed by turns.) (When the temperature is 100°C or more, hundreds digit, tens digit and ones digit are displayed by turns.)	°C

The black square (■) indicates a switch position.

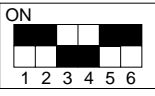
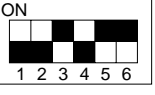
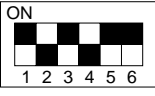
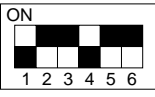
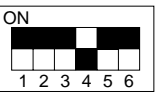
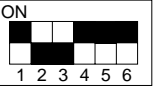
SW2 setting	Display detail	Explanation for display	Unit																
	Discharge superheat on error occurring SHd 0 – 255 [Cooling = TH4 - T _{63HS}] [Heating = TH4 - T _{63HS}]	0 – 255 (When the temperature is 100°C or more, hundreds digit, tens digit and ones digit are displayed by turns.) (Example) When 150°C; 0.5 secs. 0.5secs. 2 secs. □1 → 50 → □□	°C																
	Sub cool on error occurring SC 0 – 130 [Cooling = T _{63HS} - TH3] [Heating = T _{63HS} - TH2]	0 – 130 (When the temperature is 100°C or more, hundreds digit, tens digit and ones digit are displayed by turns.) (Example) When 115°C; 0.5 secs. 0.5secs. 2 secs. □1 → 15 → □□	°C																
	Thermo-on time until error stops 0 – 999	0 – 999 (When it is 100 minutes or more, hundreds digit, tens digit and ones digit are displayed by turns.) (Example) When 415 minutes; 0.5 secs. 0.5secs. 2 secs. □4 → 15 → □□	Minute																
	Indoor pipe temperature / Liquid (TH2 (3)) Indoor 3 -39 – 88	-39 – 88 (When the temperature is 0°C or less, “-” and temperature are displayed by turns.)	°C																
	Indoor pipe temperature / Cond./ Eva. (TH5 (3)) Indoor 3 -39 – 88	-39 – 88 (When the temperature is 0°C or less, “-” and temperature are displayed by turns.) When there is no indoor unit, “00” is displayed.	°C																
	Controlling status of compressor operating frequency	The following code will be a help to know the operating status of unit. •The tens digit <table border="1" data-bbox="836 1396 1274 1491"> <thead> <tr> <th>Display</th> <th>Compressor operating frequency control</th> </tr> </thead> <tbody> <tr> <td>1</td> <td>Primary current control</td> </tr> <tr> <td>2</td> <td>Secondary current control</td> </tr> </tbody> </table> •The ones digit (In this digit, the total number of activated control is displayed.) <table border="1" data-bbox="836 1554 1274 1785"> <thead> <tr> <th>Display</th> <th>Compressor operating frequency control</th> </tr> </thead> <tbody> <tr> <td>1</td> <td>Preventive control for excessive temperature rise of discharge temperature</td> </tr> <tr> <td>2</td> <td>Preventive control for excessive temperature rise of condensing temperature</td> </tr> <tr> <td>4</td> <td>Frosting preventing control</td> </tr> <tr> <td>8</td> <td>Preventive control for excessive temperature rise of heatsink</td> </tr> </tbody> </table> (Example) The following controls are activated. • Primary current control • Preventive control for excessive temperature rise of condensing temperature • Preventive control for excessive temperature rise of heatsink	Display	Compressor operating frequency control	1	Primary current control	2	Secondary current control	Display	Compressor operating frequency control	1	Preventive control for excessive temperature rise of discharge temperature	2	Preventive control for excessive temperature rise of condensing temperature	4	Frosting preventing control	8	Preventive control for excessive temperature rise of heatsink	Code display
Display	Compressor operating frequency control																		
1	Primary current control																		
2	Secondary current control																		
Display	Compressor operating frequency control																		
1	Preventive control for excessive temperature rise of discharge temperature																		
2	Preventive control for excessive temperature rise of condensing temperature																		
4	Frosting preventing control																		
8	Preventive control for excessive temperature rise of heatsink																		

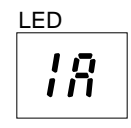

The black square (■) indicates a switch position.

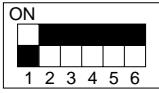
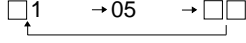
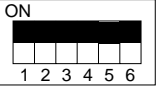
SW2 setting	Display detail	Explanation for display	Unit																
	Comp.surface temperature (TH34) -52 – 221	-52 – 221 (When the comp.shell thermistor detects 100°C or more, hundreds digit, tens digit and ones digit are displayed by turns.) (Example) When 105°C; 0.5 secs. 0.5secs. 2 secs. 	°C																
	U9 Error details (To be shown while error call is deferred.)	<table border="1"> <thead> <tr> <th>Description</th> <th>Display</th> </tr> </thead> <tbody> <tr> <td>(No error)</td> <td>00</td> </tr> <tr> <td>Overtoltage error</td> <td>01</td> </tr> <tr> <td>Undervoltage error</td> <td>02</td> </tr> <tr> <td>Input current sensor error</td> <td>04</td> </tr> <tr> <td>Abnormal power synchronous signal</td> <td>08</td> </tr> <tr> <td>PFC error (Overtoltage / Undervoltage / Overcurrent)</td> <td>10</td> </tr> <tr> <td>PFC/ IGBT error (Undervoltage)</td> <td>20</td> </tr> </tbody> </table> <p>* Display examples for multiple errors: Overtoltage (01) + Undervoltage (02) = 03 Undervoltage (02) + Power-sync signal error (08) = 0A Input current sensor error (04) + PFC error (10) = 14</p>	Description	Display	(No error)	00	Overtoltage error	01	Undervoltage error	02	Input current sensor error	04	Abnormal power synchronous signal	08	PFC error (Overtoltage / Undervoltage / Overcurrent)	10	PFC/ IGBT error (Undervoltage)	20	
Description	Display																		
(No error)	00																		
Overtoltage error	01																		
Undervoltage error	02																		
Input current sensor error	04																		
Abnormal power synchronous signal	08																		
PFC error (Overtoltage / Undervoltage / Overcurrent)	10																		
PFC/ IGBT error (Undervoltage)	20																		

PUHZ-SW40VHA

PUHZ-SW40VHA-BS

PUHZ-SW50VHA

PUHZ-SW50VHA-BS

OPERATING PROCEDURE

1. Removing the top panel, service panel, front panel and back panel

- (1) Remove the top panel fixing screws (4 × 10), one from the right and two from the left side, and detach the top panel.
- (2) Remove 1 service panel fixing screw (4 × 10) and detach the service panel by pulling it downward. (See Photo 2.)
- (3) Remove the front panel fixing screws (4 × 10), 5 from the front, 2 from the right and 2 from the left side, and detach the front panel.
- (4) Remove the back panel fixing screws (4 × 10), 4 from the right and 3 from the rear side, and detach the back panel.

PHOTOS

Photo 1

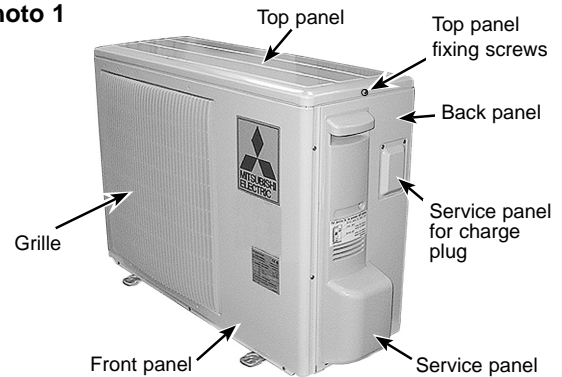
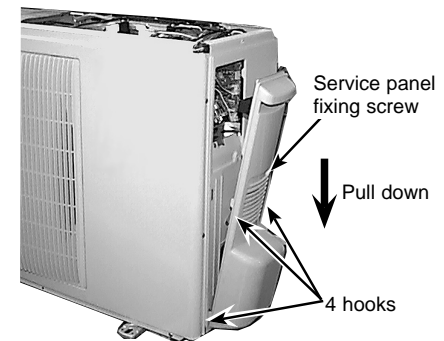

Photo 2

**2. Removing the fan motor**

- (1) Remove the top panel. (See Photo 1)
- (2) Remove the front panel. (See Photo 1)
- (3) Remove 1 nut (M6, left-screw) and detach the propeller.
- (4) Disconnect the connector CNF1 on the controller circuit board in the electrical parts box.
- (5) Loosen the clamp for the lead wire in the motor support.
- (6) Remove 4 fan motor fixing screws (4 × 18) and detach the fan motor. (See Photo 3)

Photo 3

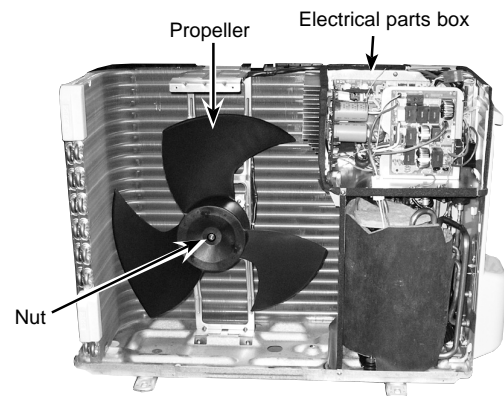
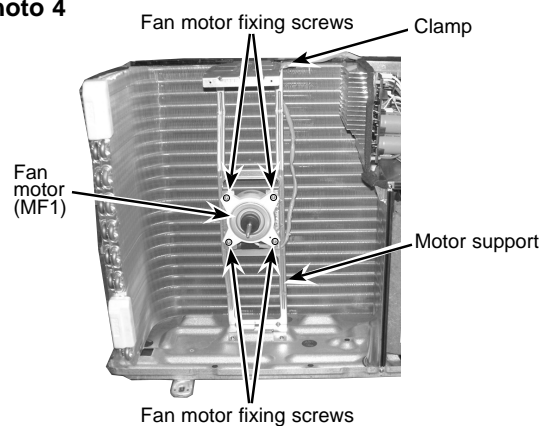
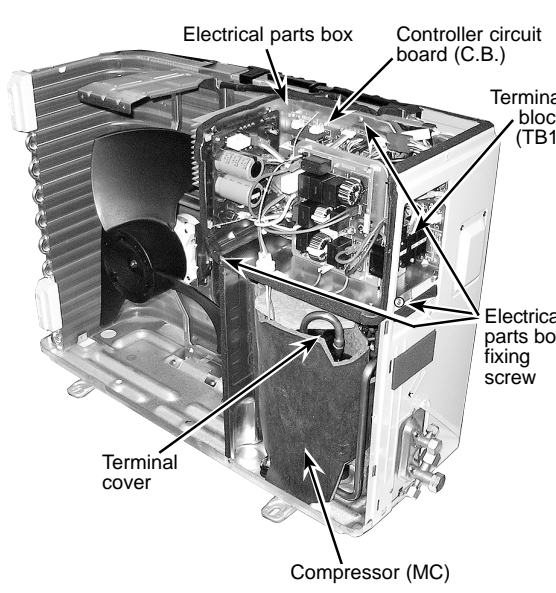
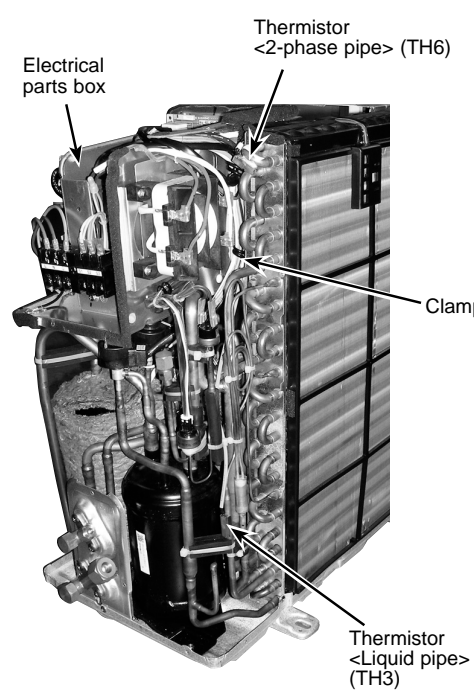
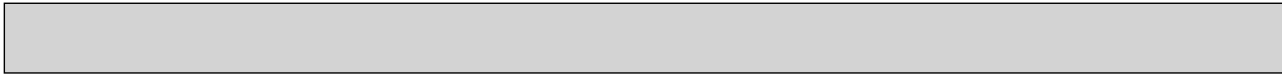

Photo 4





OPERATING PROCEDURE	PHOTOS
<p>3. Removing the electrical parts box</p> <ol style="list-style-type: none">(1) Remove the service panel. (See Photo 2)(2) Remove the top panel. (See Photo 1)(3) Remove the front panel. (See Photo 1)(4) Disconnect the indoor/outdoor connecting wire from terminal block.(5) Disconnect the connector CNF1, LEV-A and LEV-B on the controller circuit board. <Symbols on the board><ul style="list-style-type: none">• CNF1 : Fan motor• LEV-A, LEV-B : LEV(6) Disconnect the pipe-side connections of the following parts.<ul style="list-style-type: none">• Thermistor <Liquid>(TH3)• Thermistor <Discharge>(TH4)• Thermistor <2-phase pipe, Ambient>(TH6/7)• Thermistor <Comp. surface> (TH34)• High pressure switch (63H)• High pressure sensor (63HS)(7) Remove the terminal cover and disconnect the compressor lead wire.(8) Remove the electrical parts box fixing screws, 1 from the front, the right and the rear side, and detach the electrical parts box by pulling it upward.	<p>Photo 5</p>  <p>Labels in Photo 5: Electrical parts box, Controller circuit board (C.B.), Terminal block (TB1), Electrical parts box fixing screw, Compressor (MC), Terminal cover.</p>
<p>4. Removing the thermistor <2-phase pipe> (TH6) and thermistor <Liquid pipe> (TH3)</p> <ol style="list-style-type: none">(1) Remove the service panel. (See Photo 2)(2) Remove the top panel. (See Photo 1)(3) Remove the front panel. (See Photo 1)(4) Remove the back panel fixing screws, 4 from the right and 3 from the rear side, and detach the back panel. (See Photo 1)(5) Disconnect the connector TH3 (white) or TH6/7 (red) on the controller circuit board in the electrical parts box.(6) Loosen the clamp for the lead wire in the rear of the electrical parts box.(7) Pull out the thermistor <Liquid pipe> (TH3) and thermistor <2-phase pipe> (TH6) from the sensor holder. <p>Note: Replace the thermistor <2-phase pipe> (TH6) and the thermistor <Ambient> (TH7) together since they are combined. Refer to No. 5. to remove the thermistor <Ambient> (TH7).</p>	<p>Photo 6</p>  <p>Labels in Photo 6: Electrical parts box, Thermistor <2-phase pipe> (TH6), Clamp, Thermistor <Liquid pipe> (TH3).</p>



OPERATING PROCEDURE

- 5. Removing the thermistor <Ambient> (TH7)**
- (1) Remove the service panel. (See Photo 2)
 - (2) Remove the top panel. (See Photo 1)
 - (3) Remove the front panel. (See Photo 1)
 - (4) Disconnect the connector TH7 (red) on the controller circuit board in the electrical parts box.
 - (5) Loosen the clamp for the lead wire in the rear of the electrical parts box. (See Photo 6)
 - (6) Pull out the thermistor <Ambient> (TH7) from the sensor holder.

Note: In case of replacing thermistor <Ambient> (TH7), replace it together with thermistor <2-phase pipe> (TH6), since they are combined together. Refer to No.4. to remove thermistor <2-phase pipe>.

PHOTOS

Photo 7

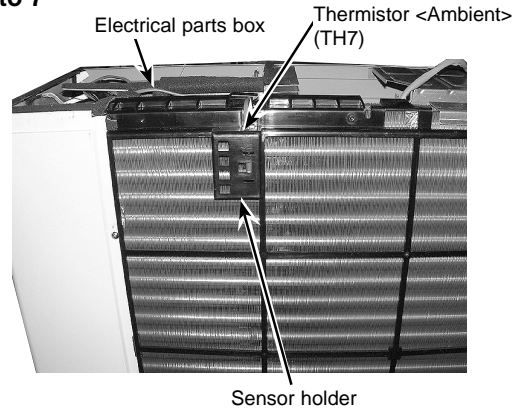

- 6. Removing the thermistor <Discharge> (TH4) and thermistor <Comp. surface> (TH34)**
- (1) Remove the service panel. (See Photo 2)
 - (2) Remove the top panel. (See Photo 1)
 - (3) Remove the front panel. (See Photo 1)
 - (4) Remove the back panel. (See Photo 1)
 - (5) Remove the electrical parts box. (See Photo 5)

[Thermistor <Discharge> (TH4)]

- (6) Pull out the thermistor <Discharge> (TH4) from the sensor holder.

[Thermistor <Comp. surface> (TH34)]

- (6) Pull out the thermistor <Comp. surface> (TH34) from the sensor holder.

Photo 8

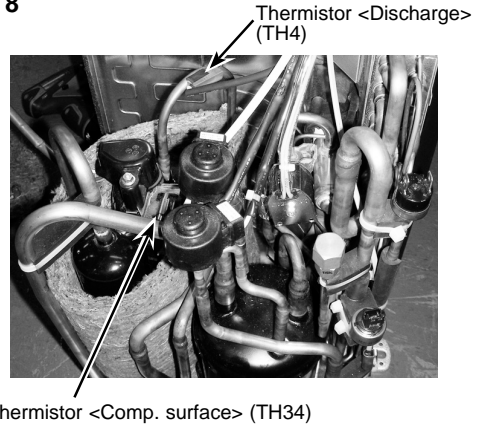

- 7. Removing the 4-way valve (21S4) and LEV coil (LEV (A), LEV (B))**

- (1) Remove the service panel. (See Photo 2)
- (2) Remove the top panel. (See Photo 1)
- (3) Remove the front panel. (See Photo 1)
- (4) Remove the back panel. (See Photo 1)
- (5) Remove the electrical parts box. (See Photo 5)

[Removing the 4-way valve (21S4)]

- (6) Remove 1 4-way valve fixing screw (M4 x 6).
- (7) Remove the 4-way valve by sliding the coil to the right.

[Removing the LEV coil (LEV (A), LEV (B))]

- (6) Remove the LEV coil by sliding the coil upward.

Photo 9

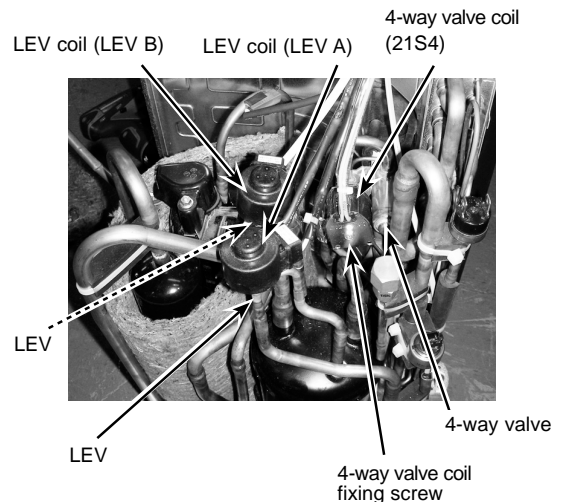

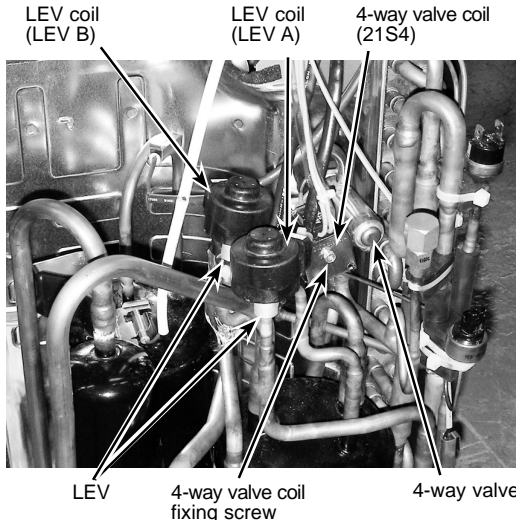
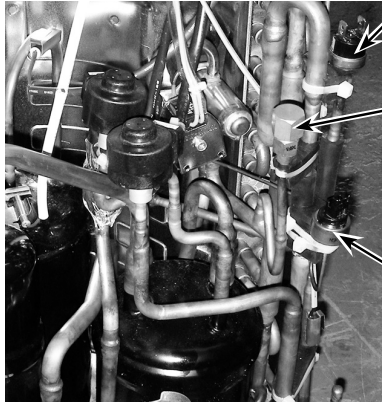
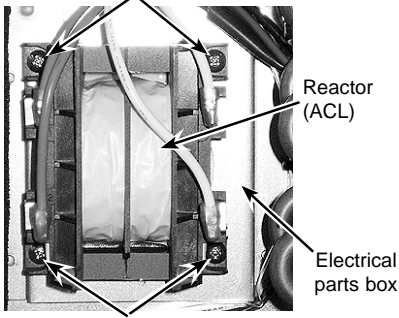

OPERATING PROCEDURE	PHOTOS
<p>8. Removing the 4-way valve</p> <ol style="list-style-type: none">(1) Remove the service panel. (See Photo 2)(2) Remove the top panel. (See Photo 1)(3) Remove the front panel. (See Photo 1)(4) Remove the back panel. (See Photo 1)(5) Remove the electrical parts box. (See Photo 5)(6) Remove the 4-way valve (See Photo 9)(7) Recover refrigerant.(8) Remove the welded part of 4-way valve. <p>Note 1: Recover refrigerant without spreading it in the air.</p> <p>Note 2: The welded part can be removed easily by removing the right side panel.</p> <p>Note 3: When installing the 4-way valve, cover it with a wet cloth to prevent it from heating (120°C or more), then braze the pipes so that the inside of pipes are not oxidized.</p>	<p>Photo 10</p>  <p>Labels in Photo 10: LEV coil (LEV B), LEV coil (LEV A), 4-way valve coil (21S4), LEV, 4-way valve coil fixing screw, 4-way valve.</p>
<p>9. Removing LEV</p> <ol style="list-style-type: none">(1) Remove the service panel. (See Photo 2)(2) Remove the top panel. (See Photo 1)(3) Remove the front panel. (See Photo 1)(4) Remove the back panel. (See Photo 1)(5) Remove the electrical parts box. (See Photo 5)(6) Remove the LEV coil. (See Photo 9)(7) Recover refrigerant.(8) Remove the welded part of LEV. <p>Note 1: Recover refrigerant without spreading it in the air.</p> <p>Note 2: The welded part can be removed easily by removing the back panel.</p> <p>Note 3: When installing the 4-way valve or LEV, cover it with a wet cloth to prevent it from heating (120°C or more), then braze the pipes so that the inside of pipes are not oxidized.</p>	<p>Photo 11</p>  <p>Labels in Photo 11: High pressure switch (63H), Charge plug, High pressure sensor (63HS).</p>
<p>10. Removing the high pressure switch (63H) and high pressure sensor (63HS)</p> <ol style="list-style-type: none">(1) Remove the service panel. (See Photo 2)(2) Remove the top panel. (See Photo 1)(3) Remove the front panel. (See Photo 1)(4) Remove the back panel. (See Photo 1)(5) Remove the electrical parts box. (See Photo 5) <p>[Removing the high pressure switch (63H)]</p> <ol style="list-style-type: none">(6) Pull out the lead wire of high pressure switch.(7) Recover refrigerant.(8) Remove the welded part of high pressure switch. <p>[Removing the high pressure sensor (63HS)]</p> <ol style="list-style-type: none">(6) Pull out the lead wire of high pressure sensor.(7) Recover refrigerant.(8) Remove the welded part of high pressure sensor. <p>Note 1: Recover refrigerant without spreading it in the air.</p> <p>Note 2: The welded part can be removed easily by removing the back panel.</p> <p>Note 3: When installing the high pressure switch, cover it with a wet cloth to prevent it from heating (100°C or more), then braze the pipes so that the inside of pipes are not oxidized.</p>	<p>Photo 12</p>  <p>Labels in Photo 12: Reactor fixing screw, Reactor (ACL), Electrical parts box, Reactor fixing screws.</p>
<p>11. Removing the reactor (ACL)</p> <ol style="list-style-type: none">(1) Remove the service panel. (See Photo 2)(2) Remove the top panel. (See Photo 1)(3) Remove the front panel. (See Photo 1)(4) Remove the back panel. (See Photo 1)(5) Remove 3 reactor fixing screws (4 x 20) and remove the reactor. <p>※ The reactor is attached to the rear of the electrical parts box.</p>	

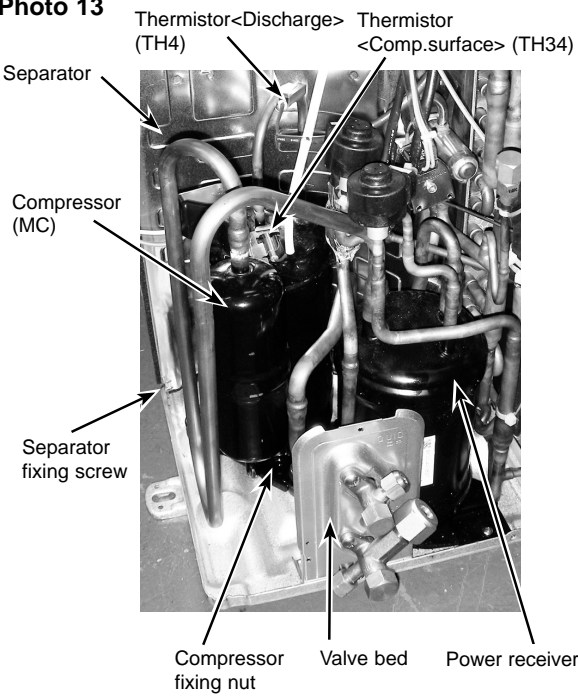
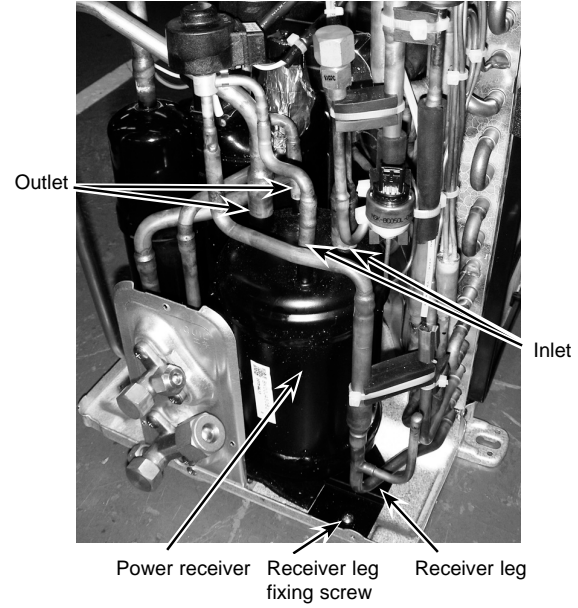
OPERATING PROCEDURE	PHOTOS
<p>12. Removing the compressor (MC)</p> <ol style="list-style-type: none"> (1) Remove the service panel. (See Photo 2) (2) Remove the top panel. (See Photo 1) (3) Remove the front panel. (See Photo 1) (4) Remove the back panel. (See Photo 1) (5) Remove the electrical parts box. (See Photo 5) (6) Remove the thermistor <Discharge> (TH4) and thermistor <Comp. surface> (TH34). (See Photo 13) (7) Remove 3 separator fixing screws (4 × 10) and remove the separator. (8) Recover refrigerant. (9) Remove 3 compressor fixing nuts by using a spanner or an adjustable wrench. (10) Remove the welded pipe of motor for compressor inlet and outlet. <p>Note: Recover refrigerant without spreading it in the air.</p>	<p>Photo 13</p> 
<p>13. Removing the power receiver</p> <ol style="list-style-type: none"> (1) Remove the service panel. (See Photo 2) (2) Remove the top panel. (See Photo 1) (3) Remove the front panel. (See Photo 1) (4) Remove the back panel. (See Photo 1) (5) Remove the electrical parts box. (See Photo 5) (6) Recover refrigerant. (7) Remove 4 welded pipes of power receiver inlet and outlet. (8) Remove 2 receiver leg fixing screws (4 × 10). (9) Remove the power receiver together with the receiver leg. <p>Note: Recover refrigerant without spreading it in the air.</p>	<p>Photo 14</p> 

MITSUBISHI ELECTRIC CORPORATION

HEAD OFFICE : TOKYO BLDG., 2-7-3, MARUNOUCHI, CHIYODA-KU, TOKYO 100-8310, JAPAN

©Copyright 2012 MITSUBISHI ELECTRIC CORPORATION
Distributed in Oct. 2012 No.OCH525
Made in Japan

New publication, effective Oct. 2012
Specifications are subject to change without notice.